

Pioneer

DVD PLAYER

DV-525

DV-525K

Operating Instructions



IMPORTANT



The lightning flash with arrowhead symbol, within an equilateral triangle, is intended to alert the user to the presence of uninsulated "dangerous voltage" within the product's enclosure that may be of sufficient magnitude to constitute a risk of electric shock to persons.

CAUTION

**RISK OF ELECTRIC SHOCK
DO NOT OPEN**

CAUTION:
TO PREVENT THE RISK OF ELECTRIC SHOCK, DO NOT REMOVE COVER (OR BACK). NO USER-SERVICEABLE PARTS INSIDE. REFER SERVICING TO QUALIFIED SERVICE PERSONNEL.



The exclamation point within an equilateral triangle is intended to alert the user to the presence of important operating and maintenance (servicing) instructions in the literature accompanying the appliance.

WARNING: TO PREVENT FIRE OR SHOCK HAZARD, DO NOT EXPOSE THIS APPLIANCE TO RAIN OR MOISTURE.

THE POWER SWITCH IS SECONDARY CONNECTED AND THEREFORE DOES NOT SEPARATE THE UNIT FROM MAINS POWER IN THE STANDBY POSITION.

CONGRATULATIONS ON YOUR PURCHASE OF THIS FINE PIONEER PRODUCT.

Pioneer is on the leading edge of DVD research for consumer products and this unit incorporates the latest technological developments.

We are sure you will be fully satisfied with the DVD player.

Thank you for your support.

Please read through these operating instructions so you will know how to operate your model properly. After you have finished reading the instructions, put them away in a safe place for future reference.

- This player is not suitable for commercial use.

This product incorporates copyright protection technology that is protected by method claims of certain U. S. patents and other intellectual property rights owned by Macrovision Corporation and other rights owners. Use of this copyright protection technology must be Authorized by Macrovision Corporation, and is intended for home and other limited viewing uses only unless otherwise authorized by Macrovision corporation. Reverse engineering or disassembly is prohibited.

Features of This Player

Compatible with DVD, Video CD and CD formats

DVDs, Video CDs and CDs that display the logos shown below can be played back on PIONEER DVD players. For more information on discs compatible with this player, refer to the table below.

Types of playable discs and their marks	Diameter/ Playable sides	Playback time	
	DVD VIDEO	Digital audio Digital video (MPEG 2)	
	12 cm/ single-sided	1 layer 2 layer	133 min. 242 min.
	12 cm/ double-sided	1 layer 2 layer	266 min. 484 min.
	DVD VIDEO*		Digital audio Digital video (MPEG 2)
	8 cm/ single-sided	1 layer 2 layer	41 min. 75 min.
	8 cm/ double-sided	1 layer 2 layer	82 min. 150 min.
	VIDEO CD	Digital audio Digital video (MPEG 1)	
	12 cm/ single-sided		Max. 74 minutes
	VIDEO CD single	Digital audio Digital video (MPEG 1)	
	8 cm/ single-sided		Max. 20 minutes
	CD	Digital audio	
	12 cm/ single-sided		Max. 74 minutes
	CD single	Digital audio	
	8 cm/ single-sided		Max. 20 minutes

The disc format logos shown above are found on disc labels or on disc jackets.

- To prevent malfunction, do not use an 8 cm adaptor (for CDs).
- Discs other than the ones indicated above cannot be played on this unit.
- DVDs that have incompatible region numbers, DVD-Audio, DVD-ROM, and CD-ROM cannot be played on this unit. The region number of the player can be found on the rear panel.

Compatible with a wide range of DVD digital audio output formats



DVDs are recorded in one of four types of digital audio formats (as of October 1998). The digital audio output jacks of this player output Dolby Digital*, DTS**, MPEG, and linear PCM digital bitstreams.

This player has a function that converts Dolby Digital and MPEG audio formats into the linear PCM format. This allows playback of DVDs recorded in Dolby Digital and MPEG without the need for a decoder.

Easy setup and adjustment using on-screen menus

Press **SETUP** on the remote control to open the Setup screen and you'll find setting up the system easy to do with on-screen menus conveniently organized and arranged. Below are just a few examples.

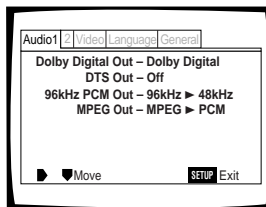

Select the digital output formats compatible with your system in the **Audio 1** menu (page 21).

Select the type of TV screen you are using in the **Video** menu (page 22).

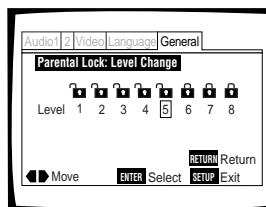
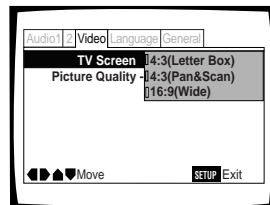

Select a parental lock level (user restriction level) to prevent children from viewing undesirable material in the **General** menu (page 43). ☆

(DV-525K only) Please note that the default on-screen display language is Chinese. To switch the on-screen display language to English, see 'Setting the on-screen display (OSD) language' on page 23.

* Manufactured under license from Dolby Laboratories. "Dolby", "AC-3" and the double-D symbol are trademarks of Dolby Laboratories. Confidential Unpublished Works. © 1992-1997 Dolby Laboratories. All rights reserved.

** "DTS" and "DTS Digital" are trademarks of Digital Theater Systems, Inc.

☆ This mark indicates this may not be possible with certain discs.

Wide range of DVD viewing options

Multi-Language Subtitles (page 28)★

You can select a subtitle language or turn subtitles off when watching movies or other media with subtitles available.

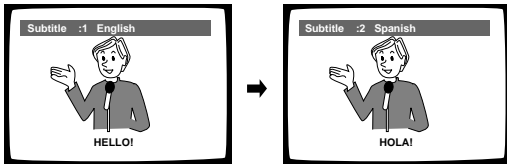

Multiple Languages (page 29)★

You can select the language on when watching movies or other media that have multiple language and/or audio soundtracks recorded on them.

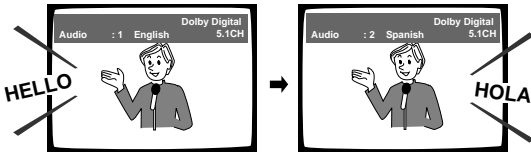

Multi-Angle (page 37)★

You can view scenes from different camera angles when watching movies or other media with multiple angle playback available.

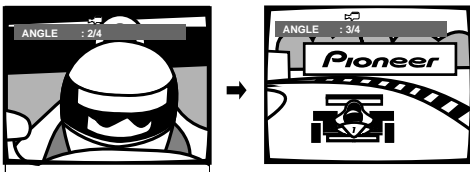

★This mark indicates this may not be possible with certain discs.

Karaoke microphone input and mixing controls (DV-525K only)

With this player, it is possible to sing along with karaoke discs or your favorite CD. You can also control the vocal mix using the volume and digital echo effect controls.



Energy-saving design

This unit is designed to use minimal electricity when this player is in standby mode. Regarding the amount of power consumed in standby mode, refer to 'Specifications' on the back cover.

Differences in Disc Composition

DVD

DVDs are divided into units referred to as titles, and titles are divided into chapters. A DVD which contains a movie may have only one title with many or no chapter divisions. Karaoke DVDs may have many titles, assigning a title to each song on the disc. Menu screens do not belong to any title.

DVD player functions generally apply to titles on a disc or chapters within a selected title. The player functions available may also vary from title to title, depending on the disc. When DVDs have a unique title division, it should be noted that search and program functions may be affected.

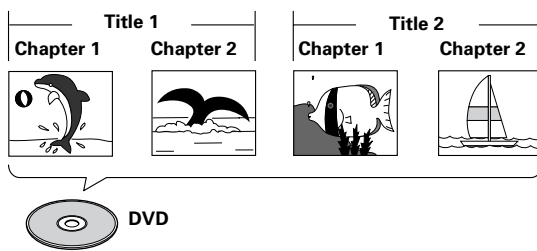

Video CD/CD

Video CDs and CDs are divided into units referred to as tracks (Video CD tracks may also be referred to as scenes). One song generally corresponds to one track. Some tracks are further divided into units referred to as indexes. Video CDs with PBC (Playback Control) also contain menus recorded on the disc which enable easy access to the contents of the disc.

When played back on a DVD player, both Video CDs and CDs are considered to be a single title, regardless of the number of tracks.

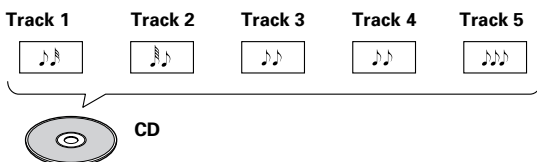
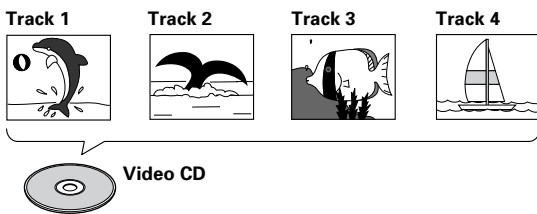

How to Proceed in This Manual

DVD is an incredible format that presents the highest quality digital audio and video available today. The amount of information that can be recorded onto a DVD is remarkable, allowing it to offer numerous functions and features available with no other format.

Because using the DVD player and DVDs may be confusing at first, following the order below should help you get through the important stages of getting set up so you can start using your player as soon as possible.

Get familiar with the player.

Refer to the section "Before Using" on page 8 to confirm that all the accessories were included with the player. If you are new to DVD, it might be beneficial for you to go through the "Names and Functions" section starting on page 10 to get familiar with the parts and buttons on the main unit and remote control as they will be referred to throughout this manual.

There is also a list of terms that can be found on page 54 if you are having trouble understanding some of the terminology associated with DVD.

Make the necessary connections.

No entertainment system seems to be set up exactly the same way. The "Making Connections" section starting on page 15 shows how video and audio connections may be made to suit your home entertainment system.

Set up the necessary player menus.

Before you can begin to enjoy the benefits of the DVD format, you should set up the player to output the video and audio information that corresponds to your system. The section "Setting Up the Player" starting on page 19 explains how to use the Setup screen menus as well as how to make the necessary initial adjustments. The Setup screen menus are used in a number of functions. Learning the procedure for operating the menus will make using this player much easier and more enjoyable.

Play a disc.

When all the connections and setups have been made, you are ready to play a DVD, Video CD, or CD with the player. The section "Getting Started Using Your DVD Player" starting on page 24 outlines the basic player operations.

Enjoy the many features available.

Once you are comfortable using the basic player functions, you are ready to take advantage of the various options DVD and this player have to offer. The section "Advanced Functions" starting on page 33 describes how to use the features available on many DVDs.

Table of Contents

Before Using 8

- Checking Accessories 8
- Preparing the Remote Control 8

Names and Functions 10

- Front Panel 10
- Display Window 11
- Rear Panel 12
- Remote Control 13

Making Connections 15

- Connecting Your DVD Player 15
- Audio Connections 16
- Video Connections 17
- System Control Connections 18

Setting Up the Player 19

- Using the Setup Screen Menus 19
- Changing to the Setup Screen
"Expert" Menu Mode 20
- Setting the Digital Audio Output To Be
Compatible with Your AV Component 21
- Setting the TV Screen Size 22
- Adjusting the OSD (On-Screen Display) 23

Getting Started Using Your DVD Player 24

- Playing DVDs, Video CDs and CDs 24
- Improving Picture Quality 25
- Chapter (Track) Skip Forward/Skip Back 26
- Forward and Reverse Scanning 26
- Stopping Playback and Switching
Power Off 27

Setting the Language Options 28

- Selecting a Subtitle Language
(Multi-Language Subtitles) 28
- Changing the Audio Language
(Multi-Language Function) 29
- Setting Language and Subtitle Preferences
in the Setup Screen Menus 30

Advanced Functions 33

- Adjusting the Dynamic Range of the
Audio Soundtrack 33
- Selecting Picture Quality Appropriate
for Program Content 33
- Singing Your Favorite Songs Along with
Karaoke Discs (DV-525K only) 34
- Still Frame/Slow Play/Frame
Advance Playback 35
- Searching for a Title, Chapter, Track, or
Location on a Disc 36
- Viewing from a Desired Camera Angle
(Multi-Angle) 37
- Repeat Play 38
- Random Play 39
- Playback in a Desired Order
(Program Play) 40
- Setting the Parental Lock Level 43
- Continuing Playback from a Specified
Location (Last Memory) 45
- Memorizing Settings for Often Viewed
DVDs (Condition Memory) 46
- Viewing Disc Information 47
- Changing the Background Color
of the Screen 48
- Resetting the Player to System Settings 48

Additional Information 49

- Disc Care 49
- For Proper and Long Use of This Unit 50
- Language Code List 51
- Troubleshooting 52
- Terms 54
- Specifications back cover

Before Using

Checking Accessories

Please confirm that the following were received with the player.

Audio cord

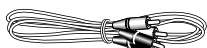

Video cord



Power cord (except for Taiwan model)

<Flat blade 2 - pin AC plug model>



<Round blade 2 - pin AC plug model>

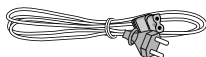

(Either of the two power cords above is supplied.)

Remote control unit

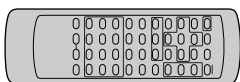

AA/R6P batteries

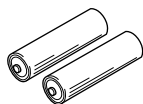

Operating instructions (this manual)

Preparing the Remote Control

Inserting batteries into the remote control

- 1 While pushing the tab on the battery compartment cover toward the center of the remote, pull out in the direction indicated by the arrow.

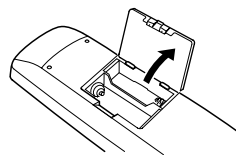

- 2 Insert batteries. Make sure to match the plus (+) and minus (-) polarity guides on the batteries with the marks inside the battery compartment.

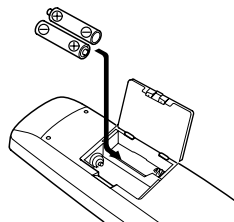

- 3 Close the cover.

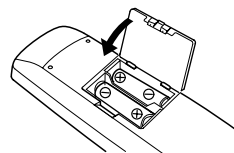

Notes

- Do not mix old and new batteries.
- When replacing batteries, use all new batteries.
- When not using the remote control for a long period of time (over 1 month), remove the batteries to avoid possible damage from battery corrosion. If battery leakage occurs, wipe the battery liquid from the battery component, then insert new batteries.

Remote control operation

When operating the remote control, point it at the remote sensor (57) located on the player's front panel. The remote control can be used up to 7 m from the player and within a 30° angle on each side of the sensor.

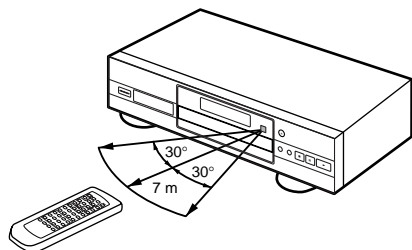

Notes

- Exposing the remote sensor to direct sunlight or strong light may cause faulty operation.
- If the CONTROL IN jack on the player's rear panel is connected to the CONTROL OUT jack of another component, point the remote control at the other component to operate the player. Operation will not be possible when pointed at this player (page 18).

Names and Functions

Front Panel

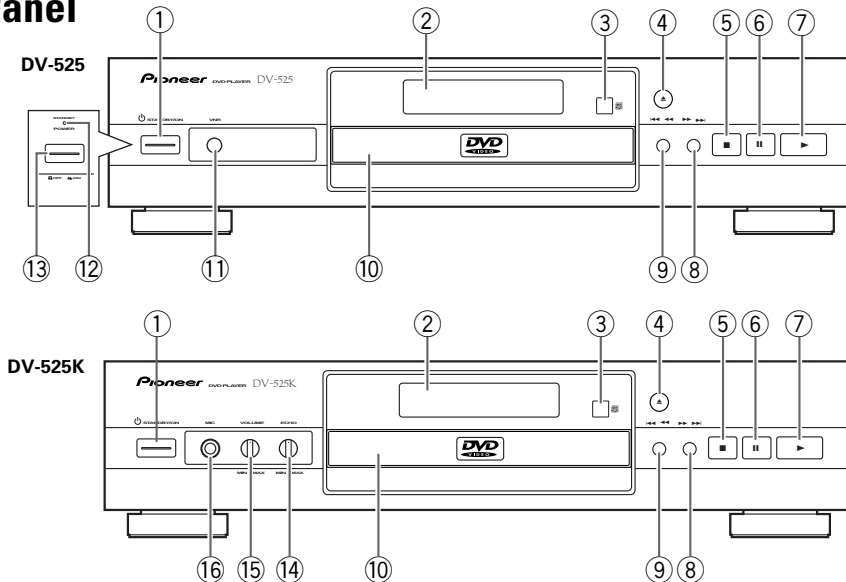

- ① **⏻ STANDBY/ON switch (DV-525K and DV-525 (Taiwan model) only)**
Press to switch the player on or to put in standby (pages 24 and 27).
- ② **Display window**
Displays system information (page 11).
- ③ **Remote sensor**
Point the remote control toward the remote sensor to operate the player (page 9).
- ④ **▲ (open/close) button**
Press to open and close the disc tray (pages 24 and 27).
- ⑤ **■ (stop) button**
Press to stop playback. Pressing once enables playback to resume from a point shortly before the location where it stopped. Pressing twice causes the disc to return to the beginning of the disc if playback starts again (page 27).
- ⑥ **⏸ (pause) button**
Press during playback to pause. Press again to resume playback (page 35).
- ⑦ **▶ (play) button**
Press to start or resume playback (pages 24 and 27).
- ⑧ **▶▶▶▶ (forward) button**
Press to advance to chapters/tracks. Press and hold to perform fast-forward scanning (page 26).
- ⑨ **◀◀◀ (reverse) button**
Press to go back to previous chapters/tracks. Press and hold to perform reverse playback scanning (page 26).
- ⑩ **Disc tray**
When loading a disc, place discs in the disc tray with the label side facing up (pages 24 and 27).
- ⑪ **VNR button (DV-525 only)**
Press to turn on the video noise reduction function (page 25).
- ⑫ **STANDBY indicator (except for DV-525K and DV-525 (Taiwan model))**
Indicates that the player is in standby, using a minimum amount of power to maintain system settings (page 27).
- ⑬ **POWER switch (except for DV-525K and DV-525 (Taiwan model))**
Press to switch the player on or off (pages 24 and 27).
- ⑭ **ECHO control (DV-525K only)**
Turn to adjust the amount of digital echo effect to add to the vocals when using the karaoke function (page 25).
- ⑮ **VOLUME control (DV-525K only)**
Turn to adjust the volume of the vocals when using the karaoke function (page 34).
- ⑯ **MIC input jack (DV-525K only)**
Use to connect a microphone (not supplied) to the player to use the karaoke function. The karaoke function is active when a microphone is connected (page 34).

Display Window

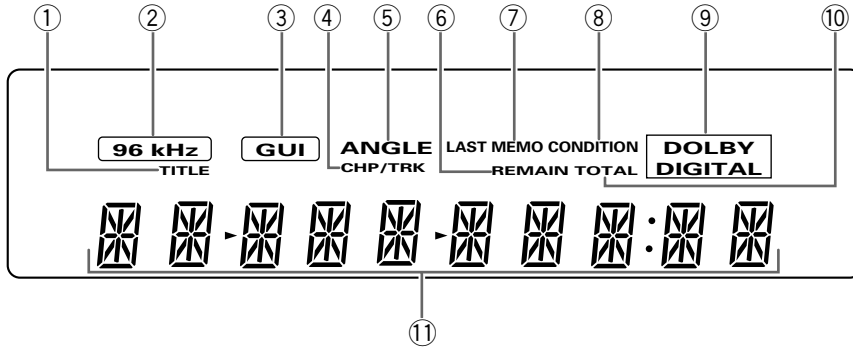

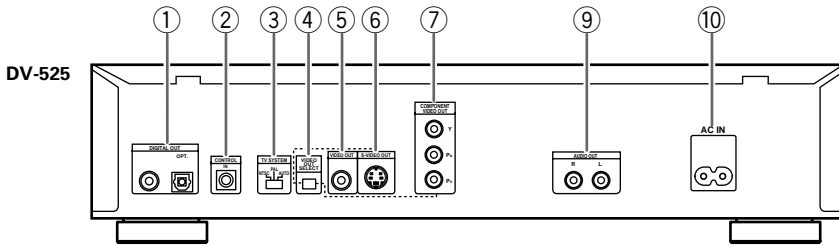

- ① **TITLE indicator**
Indicates a title number is being displayed.
- ② **96 kHz indicator**
Indicates play of a disc outputting an audio signal with a sampling frequency of 96 kHz.
- ③ **GUI indicator**
Indicates an on-screen menu operation is being performed (page 19).
- ④ **CHP/TRK indicator**
Indicates a chapter or track number is being displayed.
- ⑤ **ANGLE indicator**
Indicates Multi-Angle playback is in progress (page 37).
- ⑥ **REMAIN indicator**
Indicates that the remaining playback time of a title or chapter/track is being displayed.
- ⑦ **LAST MEMO indicator**
Indicates the Last Memory location is recorded in memory for the currently loaded DVD or Video CD (page 45).
- ⑧ **CONDITION indicator**
Indicates that Condition Memory settings are memorized for the currently loaded DVD (page 46).
- ⑨ **DOLBY DIGITAL indicator**
Indicates Dolby Digital audio playback.
- ⑩ **TOTAL indicator**
Indicates that the disc in the player is stopped and **DISPLAY** has been pressed (page 48).
- ⑪ **Counter display**
Displays the playback mode, type of disc, title and chapter/track numbers, playback time, etc.

Rear Panel

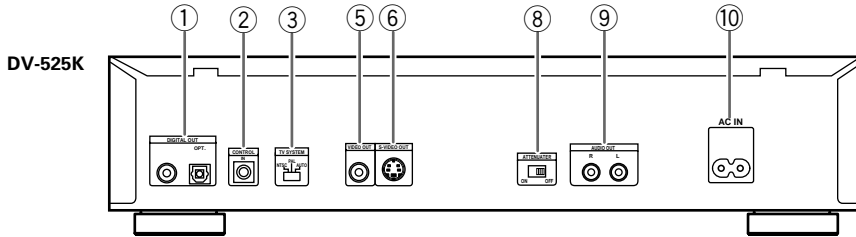

(The TV SYSTEM switch and AC IN power cord connection terminal are not present on the DV-525 Taiwan model.)



- ① **DIGITAL OUT jacks (coaxial, optical (OPT.))**
Use to output the digital audio signal recorded on discs. You can output the digital signal via either coaxial or optical output jack to an AV amplifier or receiver (page 16).
- ② **CONTROL IN jack**
Use to connect this player to another component bearing the Pioneer  mark. This lets you control this unit as though it were a component in a system. Player operations are then performed by pointing the remote control at the component that the player is connect to (page 18).
- ③ **TV SYSTEM switch (except for DV-525 Taiwan model)**
Use to change the TV signal mode to either PAL or NTSC according to the type of TV and disc to be used. When the switch is in the AUTO position, the player outputs the format on the disc as is (page 18).
- ④ **VIDEO OUT SELECT switch (DV-525 only)**
Use to set which output is used to output the video signals. Select either video/S-video or component video signal output depending on the connections you make (page 17).
- ⑤ **VIDEO OUT jack**
Connect to the video input on a TV or monitor or AV amplifier or receiver with video input capability (pages 15 and 17).
- ⑥ **S-VIDEO OUT jack**
If your TV or monitor has an S-video input, clear picture reproduction is possible by connecting the player to your TV or monitor via the S-Video jack (page 17).
- ⑦ **COMPONENT VIDEO OUT jacks (DV-525 only)**
If your projection monitor, projector or similar component has component video inputs, you can produce a higher quality picture on your projection monitor or projector by connecting to the component video outputs on this unit. When using these jacks, be sure to set VIDEO OUT SELECT to the right position (page 17).
- ⑧ **ATTENUATOR switch (DV-525K only)**
Usually set to the OFF position. When enjoying karaoke, switch to the ON position if the sound is distorted.
- ⑨ **AUDIO OUT jacks**
Use to output two-channel audio (analog) to the audio stereo inputs on a TV or stereo amplifier. If you are connecting to a receiver that has both digital and analog input jacks for DVD player connection, it may be beneficial to make both connections (pages 15 and 16).
- ⑩ **AC IN power cord connection terminal**
Use to connect the power cord to the wall outlet (page 15). (The AC power cord of the Taiwan model is built into the player.)

Remote Control

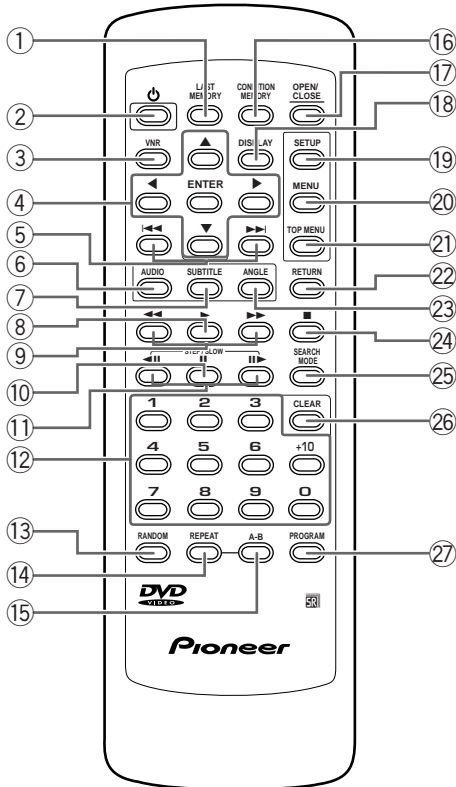

(Buttons indicated with * are used for menu operation.)

① **LAST MEMORY button**

You can resume DVD or Video CD playback from the point you last watched even if the disc is removed from the player. Press **LAST MEMORY** during playback to set a Last Memory point. When you want to resume playback of that disc, press **LAST MEMORY** in the stop mode and playback starts from the memorized point. Last Memory locations can be stored for up to 5 DVDs (or 4 DVDs and 1 Video CD) (page 45).

② **⏻ (standby/on) button**

Press to switch the player on or to put in standby (pages 24 and 27).

③ **VNR button (DV-525 only)**

Press to turn on the video noise reduction function (page 25).

④ **Cursor buttons (◀/▶/▲/▼)***

Use to move through the options on menu screens and to change settings (pages 19, 25, 40 and 43).

ENTER button*

Use to implement settings selected with the cursor buttons or to set items highlighted in a menu (pages 20 and 25).

⑤ **◀◀ (previous) / ▶▶ (next) buttons**

During playback, press ◀◀ to go back to a previous chapter/track and ▶▶ to advance to the next chapter/track (page 26).

⑥ **AUDIO button**

Press repeatedly to select one of the audio languages and/or audio formats programmed on a DVD (page 29).

For Video CD and CD, each press changes the audio output as follows.

→ Stereo → 1/L (Left) → 2/R (Right) →

⑦ **SUBTITLE button**

Press repeatedly to select one of the subtitle languages programmed on a DVD or to turn the subtitles off (page 28).

⑧ **▶ (play) button**

Press to start disc playback (pages 24 and 27).

⑨ **◀◀ (reverse) / ▶▶ (forward) buttons**

During playback of DVD and Video CD, press ▶▶ to perform fast forward scanning. Press ◀◀ to perform fast reverse scanning of DVD and Video CD. When a CD is loaded, audio scanning is performed (page 26).

- ⑩ **II (pause) button**
Press to pause playback of a disc. Press again to resume playback (page 35).
- ⑪ **STEP/SLOW ◀II/II▶ buttons**
Press **STEP/SLOW II▶** during playback to view slow playback. In pause mode, press **STEP/SLOW II▶** to advance DVDs and Video CDs frame by frame and **STEP/SLOW ◀II** to back up a few frames at a time (page 35).
- ⑫ **Number buttons (1-9, 0, +10)***
Use to perform direct title and chapter/track searches, and to input numerical values (pages 25, 36, and 40).
- ⑬ **RANDOM button**
Press to play chapters/tracks in random order (page 39).
- ⑭ **REPEAT button**
Press once to repeat playback of current chapter/track. Press twice to repeat playback of current title (page 38).
- ⑮ **A-B button**
Press at the beginning and end of the section you want to repeat or to mark a location you want to return to (page 38).
- ⑯ **CONDITION MEMORY button**
You can store in memory the settings for up to 15 DVDs. Press **CONDITION MEMORY** during DVD playback to memorize the settings (page 46).
- ⑰ **OPEN/CLOSE button**
Press to open or close the disc tray (pages 24 and 27).
- ⑱ **DISPLAY button**
Press during playback to display statistical disc information. Press repeatedly to display different information (page 47).
- ⑲ **SETUP button***
Press when the player is in either play or stop mode to open and close the Setup screen (page 19).
- ⑳ **MENU button***
Use to display or close the DVD menu screen (page 25).
- ㉑ **TOP MENU button***
Press to call up the menu programmed on the DVD. Depending on the DVD, the top menu may be identical to the DVD menu (page 25).
- ㉒ **RETURN button***
Use to go one menu back (current settings are maintained). Use **RETURN** when you do not want to change the option setting in a menu (pages 20, 25, and 44).
- ㉓ **ANGLE button**
Some DVDs are recorded with various camera angle playback options. Press **ANGLE** repeatedly to display different camera angles (page 37).
- ㉔ **■ (stop) button**
Press to stop playback. Pressing once enables playback to resume from a point shortly before the location where it was stopped. Pressing twice causes the disc to return to the beginning of the disc when playback starts again (page 27).
- ㉕ **SEARCH MODE button**
Press to perform a title, chapter/track or elapsed time search (page 36).
- ㉖ **CLEAR button**
Works in conjunction with a number of player functions. Use to cancel repeat and random playback, and to edit programs (pages 38, 39 and 40).
- ㉗ **PROGRAM button**
You can program titles, chapters, or tracks to play back in a desired order. Programs can be a maximum of 24 steps. Additionally, DVD programs for up to 24 discs can be stored in the player's memory for future use (page 40).

Making Connections

Connecting Your DVD Player

Unlike any other audiovisual media format, DVD offers a wide array of audio and video output options which allows playback to be enjoyed in any number of system configurations from a standard TV with stereo audio input to a home theater system with a projection monitor and full surround sound capabilities.

The illustrations on this and the following pages show the DV-525 round blade 2 - pin AC plug model.

Connection Guide

The illustration on this page shows the basic setup using the audio and video cords included with this player. Use this illustration as a guide to setting up your home system.

An explanation of each type of audio and video connection available can be found on the following pages. To determine the best audio and video connection setup for your system, refer to the manuals supplied with the components you are making connections to.

In addition to making physical connections to your TV or monitor, it is also necessary to assign the TV screen size in the Setup screen **Video** menu corresponding to whether you are using a wide screen or standard size TV or monitor (page 22).

Notes

- When making connections to this unit or when changing connections, check that the unit is off by pressing **POWER**, and unplug the power cord from the power outlet.
- The analog video output on this player uses copy protect circuitry to prevent the video playback on DVDs from being copied. If you connect the player to a TV via a VCR, or record and play back the contents of a disc with a VCR, the playback picture may not be normal.

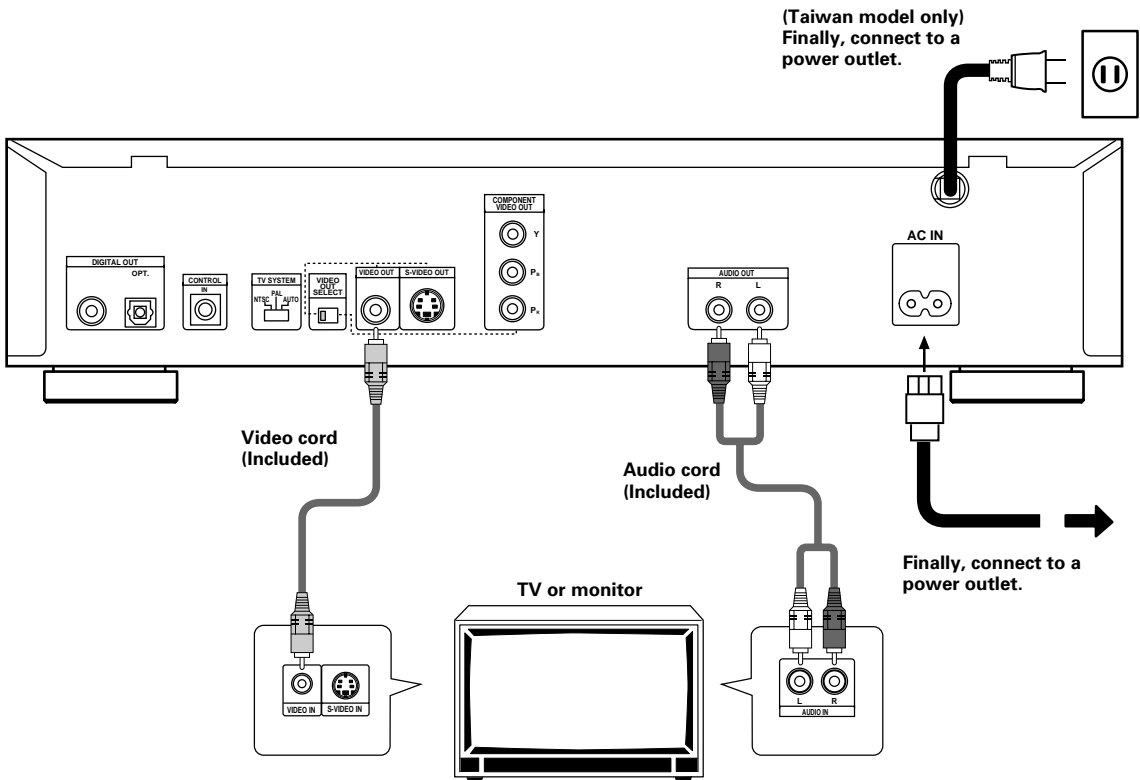

Make video connections from the VIDEO OUT jack on the player to the VIDEO IN jack on the TV or monitor using the video cord included with the player. Set the VIDEO OUT SELECT to the left position.

Make audio connections from the AUDIO OUT jacks on the player to the AUDIO IN jacks on the TV or monitor using the stereo audio cord included with the player. Be sure to match the color of the plugs with the color of the jacks (red and white).

Audio Connections

This player features two digital (optical and coaxial) and also analog audio output formats.

Digital Audio Connections:

You can enjoy the digital audio recorded on DVD discs from both optical digital and coaxial digital output jacks.

When making digital audio connections, do not make connections from both the coaxial and optical digital outputs to the same component.

When a DVD recorded in Dolby Digital, DTS, or MPEG is loaded, noise will be output if you have made connections via the digital audio jacks to a receiver or amplifier that cannot decode a Dolby Digital, DTS, or MPEG digital bitstream. In this case, be sure to set the Dolby Digital and MPEG output setting to "PCM" and set DTS output to "Off" in the **Audio 1** menu on the Setup screen. Use the **Audio 1** menu to select the type of digital output most appropriate for the system you are using (page 21).

DIGITAL OUT (Optical)

The digital signal is transmitted as light pulses through a fiber-optic cable.

- Use to connect to an AV amplifier or receiver with built-in Dolby Digital (AC-3), DTS, or MPEG decoder.
- Use a fiber-optic cable (not supplied) to connect the digital optical output on the player to the digital optical input on an AV amplifier or receiver.

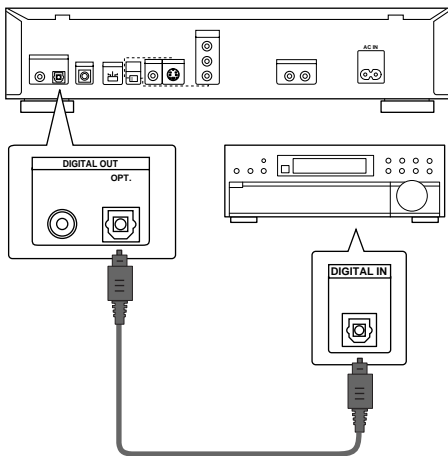

AV amplifier or receiver with built-in Dolby Digital, DTS, or MPEG decoder

DIGITAL OUT (Coaxial)

The digital signal is transmitted electronically through a coaxial cable.

- Use to connect to an AV amplifier or receiver with built-in Dolby Digital, DTS, or MPEG decoder.
- Use a coaxial cable (not supplied) to connect the coaxial digital output on the player to the coaxial digital input on an AV amplifier or receiver.

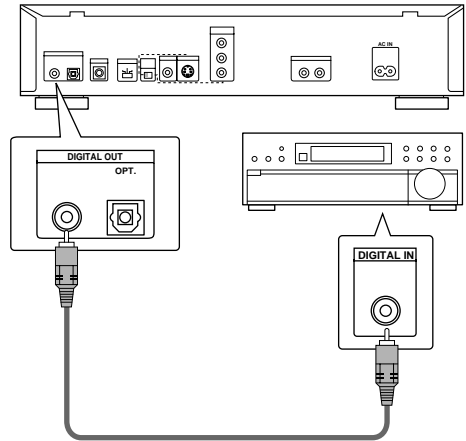

AV amplifier or receiver with built-in Dolby Digital, DTS, or MPEG decoder

Analog Audio Connection:

AUDIO OUT

- Make analog audio connections to a stereo amplifier or receiver.
- Analog audio connections can also be made to a TV or monitor with stereo input jacks.
- Use the supplied audio cable to connect the AUDIO OUT on the player to the audio input on the stereo amplifier or receiver.
- When making analog audio connections, be sure to match the color of the plugs with the color of the jacks (red and white).

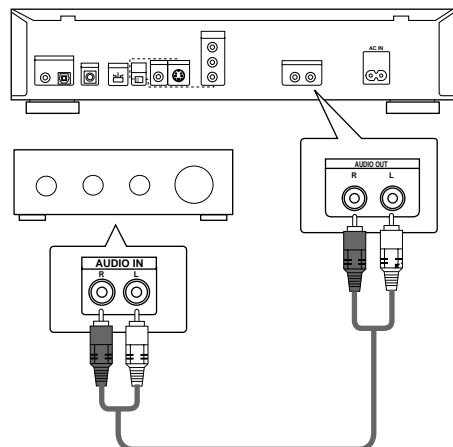

Stereo amplifier or receiver

Video Connections

This player features S-video and composite video output possibilities. Check the manual supplied with your TV or monitor to determine the best possible connection for your system.

In addition to making physical connections to your TV or monitor, it is also necessary to assign the TV screen size in the Setup screen **Video** menu corresponding to whether you are using a wide screen or standard size TV or monitor (page 22).

S-VIDEO OUT

- Make S-video connections to a TV or monitor with S-video input to produce a high quality video image.
- Use an S-video cable (not supplied) to connect the output on the player to S-video input on the TV or monitor.
- When making S-video connections, be sure to set the VIDEO OUT SELECT switch on the rear panel of the player to the left to assign S-video output.

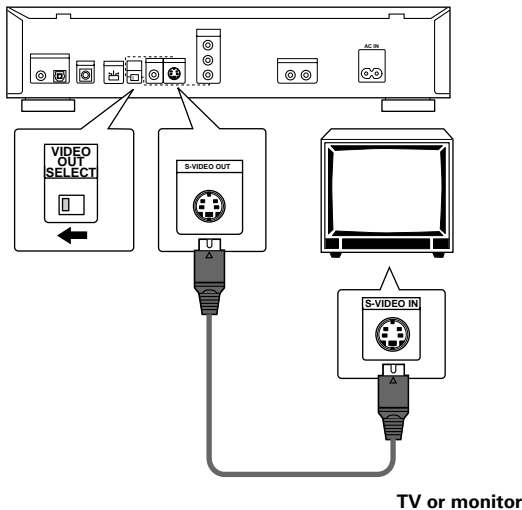

VIDEO OUT

- Make composite video connections to a standard TV or monitor with a video input jack.
- Use the supplied video cable to connect the video output jack on the player to the video input on the TV or monitor.
- Be sure to match the color of the plug with the color of the jack (yellow).
- When making video connections, make sure to set the VIDEO OUT SELECT switch on the rear panel of the player to the left to assign composite video output.

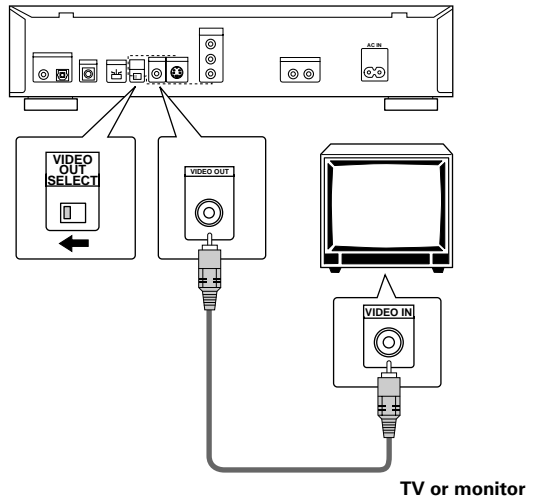

COMPONENT VIDEO OUT (DV-525 only)

- Make component video connections to a projection monitor, projector or TV with component inputs to produce a higher quality video image.
- Use component video cables or 3 video cords (not supplied) to connect the COMPONENT VIDEO OUT jacks on the player to the component jacks on the monitor.
- When making component video connections, make sure to set the VIDEO OUT SELECT switch on the rear panel of the player to the right to assign component video output.

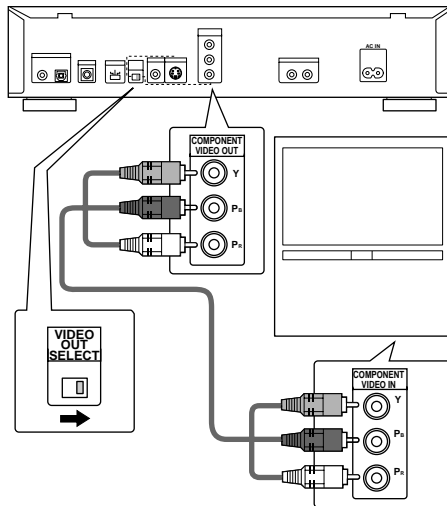

TV SYSTEM switch (except for DV-525 Taiwan model)

Video output changes as follows according to the playback disc's recorded format.

NTSC → PAL, PAL → NTSC conversion is possible on Video CDs. PAL → NTSC conversion is not possible on DVDs. When the TV SYSTEM switch is set to the AUTO position, the disc's format will be output as is. When a CD or disc is not loaded, the previous video output format will be selected.

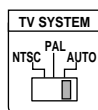

Disc		Output format		
Type	Format	Position of TV SYSTEM switch		
		NTSC	PAL	AUTO
DVD	NTSC	NTSC	MOD. PAL	NTSC
	PAL	—	PAL	PAL
Video CD	NTSC	NTSC	MOD. PAL	NTSC
	PAL	NTSC	PAL	PAL
CD, No disc		NTSC	PAL	NTSC or PAL

About MOD. (Modulation) PAL

- SHRINK
Most models of the newly developed countdown PAL TV system detect 50 Hz (PAL)/60 Hz (NTSC) and automatically switch vertical amplitude, resulting in a display without vertical shrinkage.
- If your PAL TV does not have a V-Hold control, you may not be able to view NTSC disc because the picture may roll. If the TV has a V-Hold control, adjust it until the picture stops rolling. On some TVs, the picture may shrink vertically, leaving black bands at the top and bottom of the screen. This is not a malfunction; it is caused by the NTSC → PAL conversion.

System Control Connections

Using a commercially available cord with a mini plug (3.5 mm dia. with no resistance) to connect this player's CONTROL IN jack to the CONTROL OUT jack of another PIONEER component bearing the SR mark, you can control the player as though it were a component in a system (system control).

- If you connect for system control, you cannot operate the player directly. Point the remote control unit at the component (AV amplifier, etc.) connected to the CONTROL OUT jack to operate.
- When controlling as a system, be sure to make a connection to the amplifier **using an audio or video cord**, even when using only digital components.
- For details, refer to the operation manuals of the connected components.

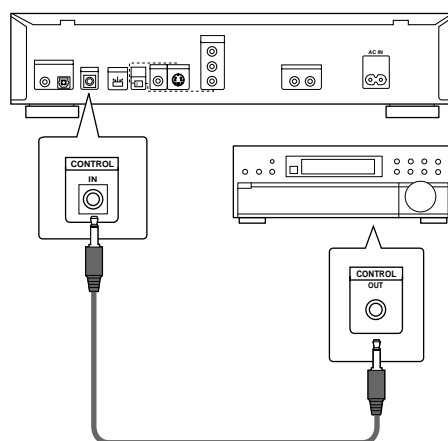

Pioneer component with SR mark.

Setting Up the Player

Using the Setup Screen Menus

The procedure on this page describes how to operate the menus on the Setup screen. These menus are used to set and adjust a number of system settings. The various functions that can be adjusted are covered throughout this manual. The procedure on this page provides a basic outline for using the Setup screen menus.

When setting up for the first time

Some DVDs start playing automatically when loaded in the player. It is therefore recommended to set the **Audio 1** menu options (if digital audio connections have been made) and **Video** menu options before loading a DVD for the first time. If a DVD has been loaded, be sure to press **■ (stop)** before proceeding.

Procedures in this section use the DV-525K and the DV-525 (Taiwan model) as models. Differences in procedures between models are clearly marked by white numbered steps.

Note

The default on-screen display language of the DV-525K is Chinese. If you would like to switch the display language to English to use the menu screens, make changes to the [OSD Language] setting in the Setup screen Language menu (page 23).

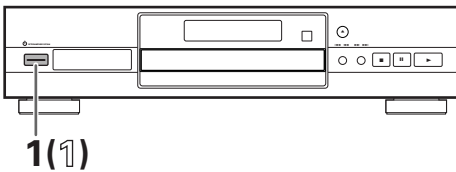
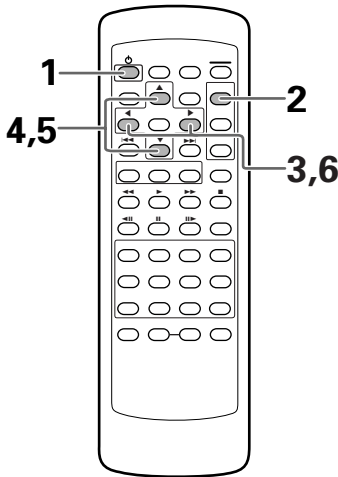

1 Press **STANDBY/ON** on the front panel (on the remote control). (DV-525K and DV-525 (Taiwan model) only)

1 Press **POWER** on the front panel. (DV-525 only (except for Taiwan model))

2 Press **SETUP**.
The Setup screen appears.

(Example)

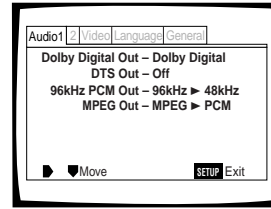

3 Use the cursor buttons (/) to select the menu you want.

As each menu is selected with the cursor, the settings appear below the menu heading.

4 Press the cursor button () to enter the menu.

The top item within the menu becomes highlighted.

(Example)

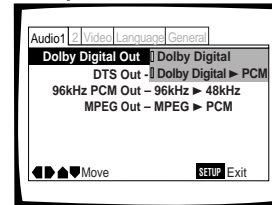

5 Use the cursor buttons (/) to select the setting you want to change.

The options available for each setting appear to the right when the setting is selected. The current setting appears with the setting indicator lit.

6 Press the cursor button () to enter the setting options.

(Example)

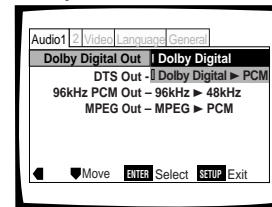

- Not all menu options can be changed while a disc is playing. In these cases, the options appear grayed out on the screen and cannot be adjusted. To change these settings, press **■ (stop)** first before pressing **SETUP**.
- Operating the menu after pressing **■ (stop)** may cancel the resume function.
- Some menu options are not immediately effective if set while a disc is playing. To make these settings effective, stop playback and then start again, or change the settings while the disc is stopped.

Changing to the Setup Screen “Expert” Menu Mode

The Setup screen menus are divided into two levels, “Basic” and “Expert”, to make this unit more convenient to operate for different levels of users. The “Basic” menu mode contains functions that may be considered necessary for the basic operations of this player. The “Expert” menu mode adds to the “Basic” menu mode additional functions of the player that can be adjusted to further personalize performance of the player. Though it doesn’t require an expert to use the “Expert” menu mode, selecting the “Basic” menu mode may make setting up easier to do.

In this manual, functions that are contained in the “Expert” menu mode are identified by the  icon.

Make changes to the [Setup Menu Mode] setting in the Setup screen **General** menu.

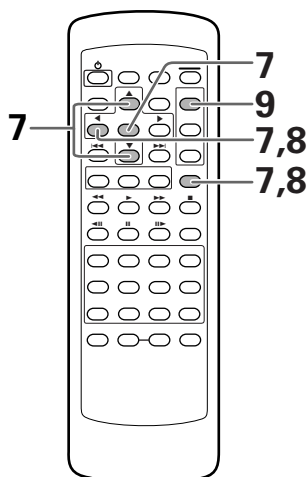

7 Use the cursor buttons (▲/▼) to select a new setting and press **ENTER** to set the new setting in memory. Press **RETURN** or the cursor button (◀) to exit the options without making any changes.

8 Press **RETURN** or the cursor button (◀) to go back to the main menu bar to select another menu.

9 Press **SETUP** to close the Setup screen. The Setup screen closes.

How to interpret the setting indicator colors in the Setup screen menus

When setting up the system, or when making adjustments, it is convenient to know what settings are applicable to the different disc formats. When the settings appear for each menu option, the currently selected setting appears with the setting indicator highlighted in one of three colors: blue, green or yellow. These colors correspond to what formats the menu option effects as shown in the table below.

Color of indicator	Disc format(s)
Blue	DVD only
Yellow	DVD / Video CD
Green	All compatible formats

Note

If a setting applicable only to DVDs is changed while a Video CD or CD is loaded, a blue DVD icon appears in the upper right hand corner of the screen to indicate that the setting is not applicable to the currently loaded disc. The setting will be effective the next time a DVD is loaded.

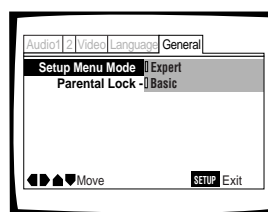

Settings: **Expert**
Basic*

* Factory setting

Setting the Digital Audio Output To Be Compatible with Your AV Component – DVD

This player is capable of digital audio output for Dolby Digital, DTS, MPEG, and signals with a sampling rate of 96 kHz. Make settings in the Setup screen **Audio 1** menu to reflect the capabilities of the components that you have made digital connections to.

Note

If you have made only stereo line connections (analog) using the supplied audio cord, it is not necessary to make any changes in this menu.

Dolby Digital Out

This player is capable of outputting the Dolby Digital surround sound audio signal. When the player is connected to an AV component that has a built-in Dolby Digital decoder, select "Dolby Digital". This player can also convert the Dolby Digital signal to a digital Linear PCM signal, the same digital signal output from a CD. Select "Dolby Digital ▶ PCM" when you have made connections to an amplifier or receiver with a Dolby Pro Logic decoder or a Digital Analog Converter (DAC).

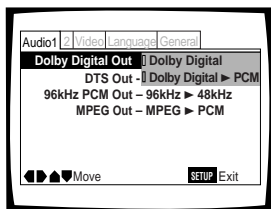

Settings: **Dolby Digital***
Dolby Digital ▶ PCM

*Factory setting

DTS Out

This player is capable of outputting DTS digital audio for DVDs recorded in DTS. When this player is connected to an AV component that has a built-in DTS decoder, select "DTS". If your system is not equipped to decode DTS, select "Off". Refer to the operating instructions supplied with your audio components if you are unsure about compatibility with DTS.

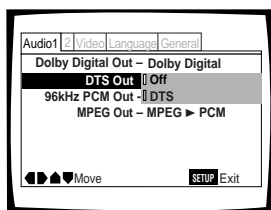

Settings: **Off***
DTS

* Factory Setting

Notes

- If you have made digital audio connections to component(s) not equipped to decode the DTS digital bitstream, be sure to select "Off". If a DTS signal is output without decoding, the output is digital noise that could potentially cause damage to your speakers.

96 kHz PCM Out

This player is capable of outputting digital signals with a sampling frequency of 96 kHz. If you have made connections to a component capable of processing this signal rate, select "96 kHz" for the signal to be output as is. As some components are incapable of processing digital signal input with sampling rates of 96 kHz, selecting "96 kHz ▶ 48 kHz" compresses the signal to a standard signal with a sampling rate of 48 kHz.

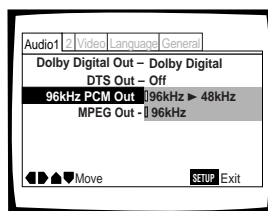

Settings: **96 kHz ▶ 48 kHz***
96 kHz

* Factory Setting

MPEG Out

This player is capable of outputting the MPEG digital bitstream. When the player is connected to an AV component that has a built-in MPEG decoder, select the "MPEG" setting. Otherwise, select "MPEG ▶ PCM" to convert the digital signal to the PCM signal, the digital signal output from a CD.

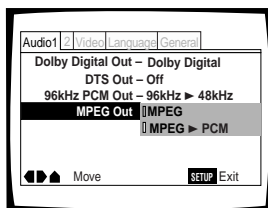

Settings: **MPEG**
MPEG ▶ PCM*

* Factory Setting

Setting the TV Screen Size

The width-to-height ratio of conventional TVs is 4:3, while the width-to-height ratio of wide screen and high-definition TVs is 16:9. This width-to-height ratio is called the aspect ratio.

When viewing software recorded in different aspect ratios, the image's height to width ratio can be switched to match the TV or monitor being used.

Make changes to the TV screen size in the [TV Screen] setting in the Setup screen **Video** menu. Please note that changes to the [TV Screen] setting cannot be made when a disc is playing. Stop playback of the disc before attempting to make any changes.

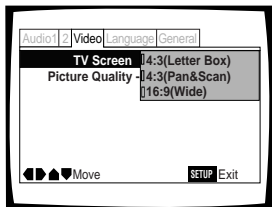

Settings: **4:3 (Letter Box)**
4:3 (Pan & Scan)
16:9 (Wide)*

* Factory Setting

Notes

- Whether the aspect can be switched or not depends on the disc. Please refer to the information written on the disc jacket, etc.
- Some discs may not include the screen format selected in the [TV Screen] setting. When this occurs, the standard TV screen format available on the disc is automatically selected.

Differences in screen sizes and DVD formats

The number of screen size formats currently available can be somewhat confusing. If set incorrectly, the video presentation may not appear as it should. The following diagrams and descriptions are intended to help you set your TV screen size in a way that will allow you to fully enjoy the digital video of DVD.

The settings in the [TV Screen] setting are perhaps most applicable when the DVD you are watching is programmed in the wide screen format. If you have a standard TV, select either "4:3 Letter Box" or "4:3 Pan & Scan" based on your personal preference. If you have a wide screen TV, select "Wide".

When viewing a wide screen TV or monitor	
DVD screen size format	Setting and Appearance
Wide screen format DVD Please note that there are some wide screen letter box formats that place black bars at the top and bottom of the screen. This is not a malfunction.	<p>"Wide" setting</p>
Standard screen format DVD When viewing a standard screen format DVD on a wide screen TV, black bars may be automatically placed at the side of the screen to adjust to the DVD format.	<p>"Wide" setting</p>
Standard screen format DVD (unnatural stretched effect) If you are viewing a standard screen format DVD on a wide screen TV, the picture may appear 'stretched' on the screen. To remedy this condition, change your wide screen TV to display a standard (4:3) screen. Refer to the instructions supplied with your wide screen TV or monitor for more information.	<p>"Wide" setting</p>

When viewing a standard size TV or monitor	
DVD screen size format	Setting and Appearance
Wide screen format DVD The Letter box presentation places black bars at the top and bottom portions of the screen to provide the full wide screen presentation of a movie on a standard TV (4:3 aspect ratio).	<p>"Letter Box" setting</p>
Wide screen format DVD The Pan & Scan presentation crops both sides of the wide screen presentation to use the full standard TV screen.	<p>"Pan & Scan" setting</p>
Standard screen format DVD If you have a standard TV, the standard screen format will be presented regardless of the setting.	<p>Any setting</p>
Wide screen format DVD (unnatural squeezed effect) If you are viewing a wide screen format DVD on a standard TV and the [TV Screen] setting is set to "Wide", the picture may appear 'squeezed' on the screen. To remedy this condition, select either "Letter Box" or "Pan & Scan".	<p>"Wide" setting</p>

Adjusting the OSD (On-Screen Display)

Setting the on-screen display (OSD) language

This setting is used to establish the language that operation indicators and on-screen messages and operations display. Change this setting in the Setup screen **Language** menu [OSD Language] setting.

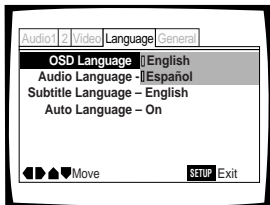

Settings: **English***
Español

* Factory Setting

Note

The languages that can be selected may be different from those shown above.

Setting the position of the on-screen display Expert

When watching conventional software on a wide screen TV, the operation display is at the very top of the screen, and may be difficult to see. When this occurs, selecting "Wide" changes the position of the display and lets you see operation indicators clearly even on a wide screen TV. Otherwise, select "Normal".

Make changes in the [OSD Position] in the Setup screen **Video** menu in the "Expert" menu mode (page 20).

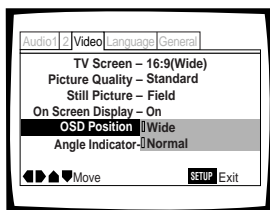

Settings: **Wide**
Normal*

* Factory Setting

Turning the on-screen display on or off Expert

If you would rather not have the operation indicators (Play, Stop, Resume, etc.) and other messages displayed on the screen, it is possible to turn them off in the [On Screen Display] setting in the Setup screen **Video** menu in the "Expert" menu mode (page 20).

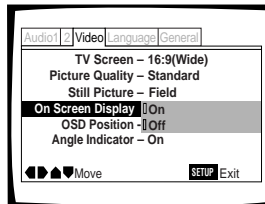

Settings: **On***
Off

* Factory Setting

Getting Started Using Your DVD Player

Playing DVDs, Video CDs and CDs – DVD/Video CD/CD

Before you can start to enjoy the digital audio and video on DVDs, be sure that you have made the necessary settings in the Setup screen menus outlined in the previous section to correspond to your home system. Having made these settings, you are now ready to start using the player to enjoy DVDs, Video CDs, and CDs.

Illustrations of the player in this section show the DV-525K. Differences in the different models are as follows.

- The MIC input jack, **VOLUME** and **ECHO** controls are not present on the DV-525.
- The **STANDBY/ON** switch is not present on the DV-525 (except for Taiwan model).

Procedures in this section use the DV-525K and the DV-525 (Taiwan model) as models. Differences in procedures between models are clearly marked by white numbered steps.

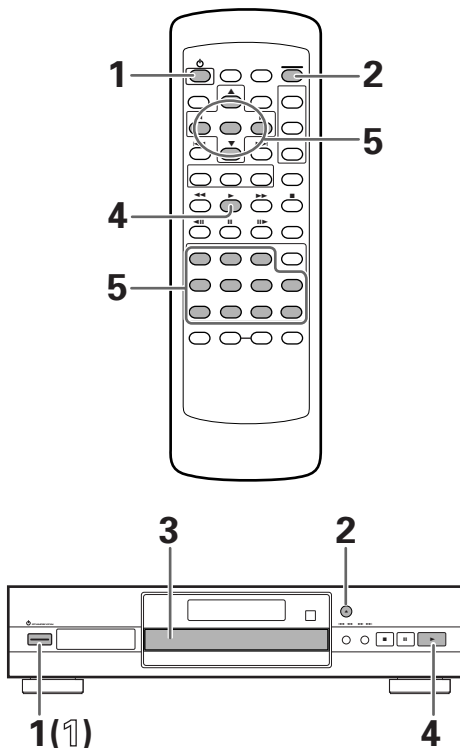

- 1 Press **STANDBY/ON** (⏻) on the front panel (⏻ on the remote control). (DV-525K and DV-525 (Taiwan model) only)

- 1 Press **POWER** on the front panel. (DV-525 only (except for Taiwan model))

- 2 Press **OPEN/CLOSE** (⏏) on the front panel. The disc tray comes out.

- 3 Load a disc. Load a disc with the label side facing up, using the disc tray guide to align the disc.

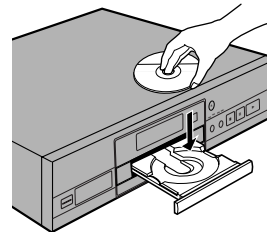

- 4 Press **▶ (play)** (▶) on the front panel.
 - The disc tray closes, and playback begins.
 - **Depending on the disc, a menu may be displayed. If a menu is displayed, proceed to step 5.**

- 5 Select the item you want to view.
 - When a DVD is loaded: Select the item with the cursor buttons (◀/▶/▲/▼) or the number buttons, then press **ENTER**.
 - When a Video CD is loaded: Use the number buttons to select the item.

Notes

- Noise is output if you make digital audio connections to a receiver or amplifier that does not have a built-in decoder. Check that the digital audio output format selected in the **Audio 1** menu corresponds to the audio components you have made connections to (page 21).
- The TV screen size is factory set to present the wide screen format (16:9 aspect ratio). If you have a standard TV screen (4:3 aspect ratio), this setting can be changed to match your TV screen size in the **Video** menu (page 22).

When an operation is prohibited

There are times when you are using the player and attempt to perform an operation, but for some reason it cannot be performed. When this occurs, one of the two following icons appear on the screen.



The operation is prohibited by the player.



The operation is prohibited by the programming on the disc.

When a menu screen is displayed

Menu screens are displayed for DVDs that have menu screens or Video CDs that include Playback Control (PBC). DVDs often contain extra information that can be accessed in the DVD menu and sometimes makes navigating DVD menu screens as enjoyable as watching the feature presentation.

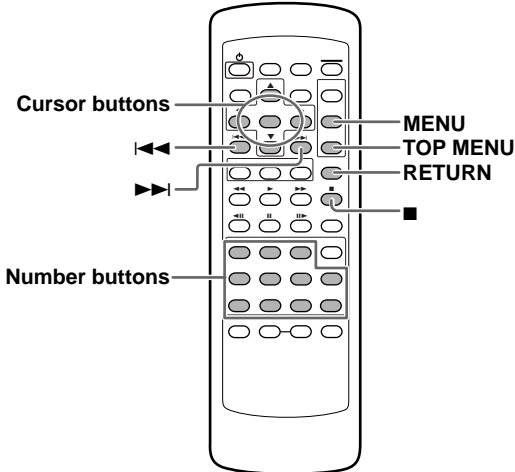

Example: When a DVD that has menu screens is loaded

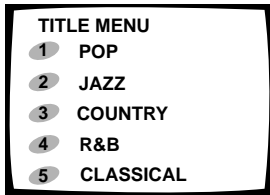

Example: When a Video CD that has Playback Control is loaded

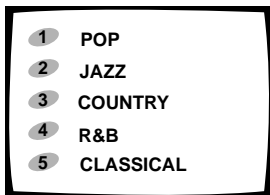

To open or return to the DVD or Video CD menu screen

Although this differs depending on the disc, pressing **MENU**, **TOP MENU**, or **RETURN** during DVD playback or **RETURN** during Video CD playback displays the menu screen. Refer to the DVD or Video CD disc jacket and accompanying documentation for more information.

To navigate a menu screen

- Although individual DVD titles may differ, when a menu screen is displayed, use the cursor buttons (◀/▶/▲/▼) and **ENTER** on the remote control. The cursor buttons are used to move around the options on the screen and **ENTER** is used for selection.
- Occasionally, the number buttons may also be used to make selections. If this is possible, using number buttons serves to directly select an option on a menu screen. Only number buttons are used to make selections on Video CD menu screens.
- When the Video CD has more than one menu, pages can be advanced to or returned to with **1◀◀** or **▶▶1**.

To play Video CDs without displaying menu screens

Video CDs with Playback Control (PBC) display a menu screen when play is started. It is possible, however, to play back Video CDs without displaying menu screens. When a Video CD with PBC is loaded, press **■**, and then the number button of the track you want to play.

Improving Picture Quality

– DVD/Video CD (DV-525 only)

If the video picture of a DVD or Video CD displays a lot of video noise (tiny flecks or spots on that appear randomly and briefly on the screen), using this player's video noise reduction feature may be able to reduce the amount of video noise and improve the overall quality of the video image.

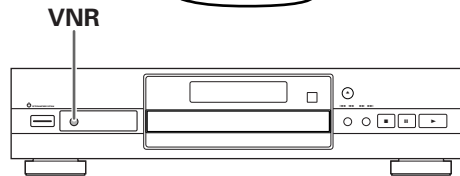
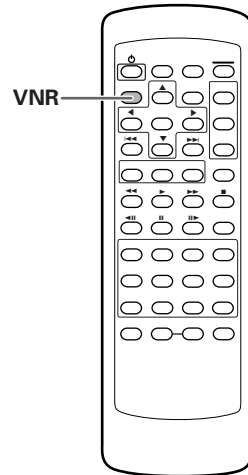

Press **VNR** to turn video noise reduction on.

- The VNR indicator lights when this function is on.
- Press VNR again to turn video noise reduction off.

Chapter (Track) Skip Forward/ Skip Back – DVD/Video CD/CD

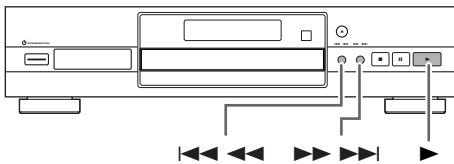
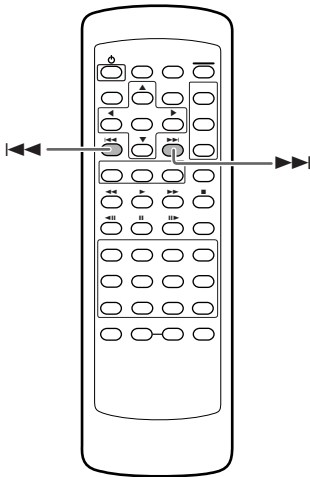

Advancing to the next chapter (track)

Press **▶▶ (next)** (▶▶ ▶▶) on the front panel).

- Press to skip forward to the next chapter (track).
- When a CD is loaded, you can advance more than one track forward by pressing and holding **▶▶** and releasing when the desired track number appears in the display.

Skipping back to the previous chapter (track)

Press **◀◀ (previous)** (◀◀ ◀◀) on the front panel).

- Press once to skip back to the start of the chapter (track) currently playing.
- Press twice to skip back to the start of the previous chapter (track).
- When a CD is loaded, you can skip back to the track you want to hear by pressing and holding **◀◀** and releasing when the desired track number appears in the display.

Forward and Reverse Scanning

– DVD/Video CD/CD

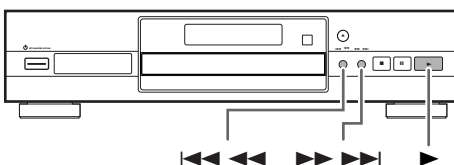
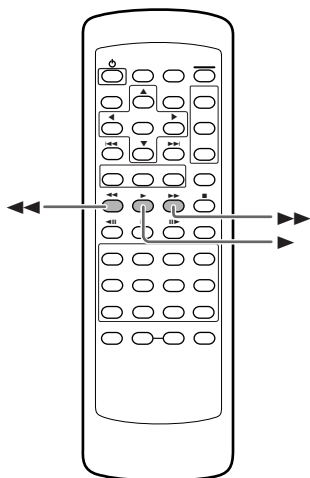

Fast forward scanning

Press and hold **▶▶▶ (forward)** (▶▶▶▶) on the front panel) during playback.

- Release **▶▶▶** when you reach the desired location. Normal playback resumes.
- When the “Scan” indicator on the screen changes from flashing to lit, fast forward scanning will continue even if the button is released. When the desired location has been reached, press **▶**.

Fast reverse scanning

Press and hold **◀◀◀ (reverse)** (◀◀◀◀) on the front panel) during playback.

- Release **◀◀◀** when you reach the desired location. Normal playback resumes.
- When the “Scan” indicator on the screen changes from flashing to lit, fast reverse scanning will continue even if the button is released. When the desired location has been reached, press **▶**.

Stopping Playback and Switching Power Off

– DVD/Video CD/CD

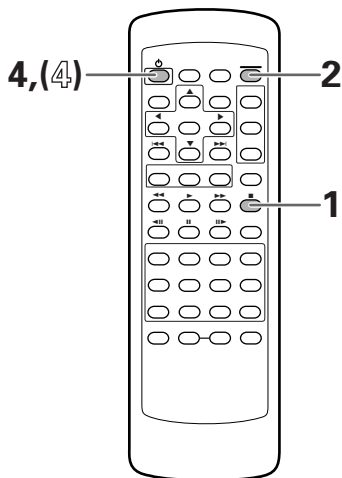

- 1 Press **■ (stop)** (■ on the front panel).
Playback stops.
- 2 Press **OPEN/CLOSE** (▲ on the front panel).
The disc tray comes out.
- 3 Remove the disc.

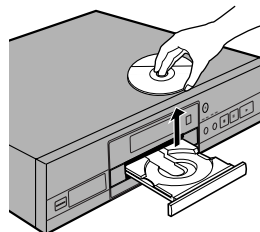

- 4 Press **STANDBY/ON** (⏻ on the front panel (⏻ on the remote control).
- 4 Press ⏻ on the remote control.
The disc tray goes back in.
- 5 Press **POWER** on the front panel to turn the player's power off.

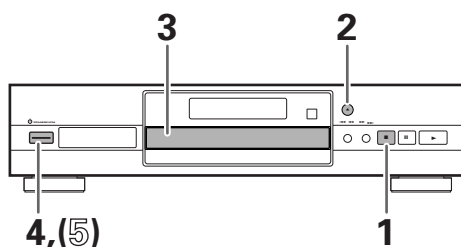

Resuming playback from where you stopped — DVD/Video CD

With this player, it is possible to resume play of a DVD even when play has been stopped.

Press **■ (stop)** once to enable play to resume from a point shortly before the DVD was stopped when **▶ (play)** is pressed again.

- Pressing **■ (stop)** twice causes the disc to return to the beginning when **▶ (play)** is pressed again.
- When **■ (stop)** is pressed, "RESUME" appears in the display for as long as resume playback is possible. If the function is canceled, "RESUME" disappears and the disc format appears in the display.

Note

Resume play is only possible when the power is kept on, the disc is loaded, and **■ (stop)** has not been pressed twice in succession ("RESUME" appears in the display). If you want to continue viewing a DVD at a later time or date, it is recommended to use the Last Memory function described on page 45.

Setting the Language Options

DVDs have the capacity to contain a great deal of audio information, which includes the ability to hold up to 8 different language tracks and subtitle information in as many as 32 different languages. This section outlines the variety of audio language and subtitle options available with this player.

In this section, you'll be able to:

- **Select one of the subtitle languages programmed on a DVD or turn the subtitles off using the remote control (this page).**
- **Select one of the languages programmed on a DVD using the remote control (page 29).**
- **Change the audio output type when using Video CDs and CDs (page 29).**
- **Set preferences for audio and subtitle language (page 30).**
- **Set preferences for the language to be displayed by the DVD menu (page 31).**
- **Set Auto Language to display subtitles only for foreign films (page 32).**
- **Select whether to have the subtitles turned on or off, and even opt to select assist subtitles for viewers who are hard of hearing (page 32).**
- **Select the language of subtitles that are displayed even when the subtitles are turned off (page 32).**

Notes

- DVDs differ in content and do not all contain multiple language or subtitle information. Therefore making settings in this section may have no effect on some DVDs.
- The default on-screen display language of the DV-525K is Chinese. If you would like to switch the display language to English to use the menu screens, make changes to the [OSD Language] setting in the Setup screen Language menu (page 23).

Selecting a Subtitle Language (Multi-Language Subtitles)

– DVD

You can select a desired subtitle language with DVDs that have subtitle data in multiple languages recorded on them.

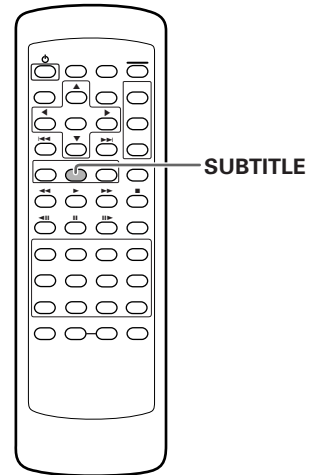
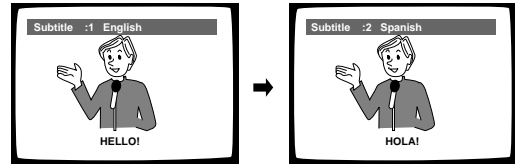

Press **SUBTITLE** repeatedly during playback.

Pressing **SUBTITLE** once displays the currently selected subtitle language. Subsequent presses rotate through the subtitle languages available on the DVD.

Notes

- The subtitle language cannot be switched if the subtitle language is not recorded, or if only one language is recorded.
- Switching the subtitle language may not be possible with some discs. In this case, the  mark will be displayed.
- To clear subtitles during playback, press **SUBTITLE** and then press **CLEAR**, or press **SUBTITLE** until "Off" appears.
- For some discs, subtitle language selection can be made using the menu on the DVD. In this case, press **MENU** to display the DVD menu screen and then make your selection.

Changing the Audio Language (Multi-Language Function) – DVD

Dolby Digital, PCM, and other audio data can be recorded on DVDs in a number of languages or audio tracks, letting you choose the desired language or audio.

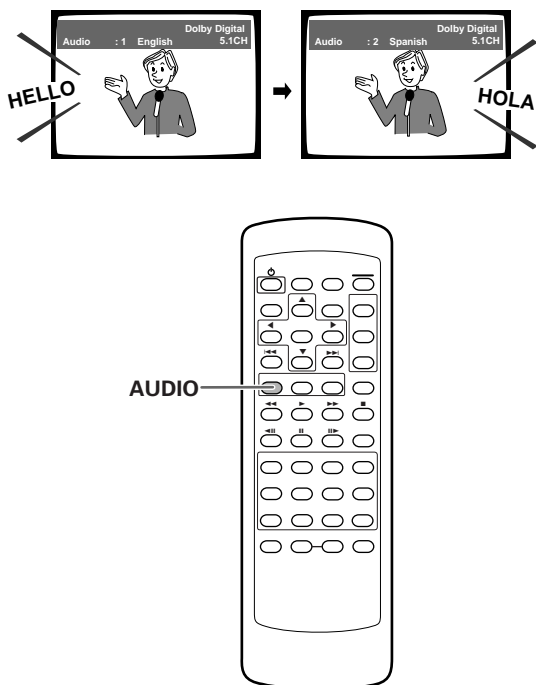

Press **AUDIO** repeatedly to select the desired language.

Pressing **AUDIO** once displays the currently selected language. Subsequent presses rotate through the audio languages available on the DVD.

Notes

- You cannot switch languages if there is only one language recorded on the disc.
- Switching the audio language may not be possible with some titles. In this case, the  mark is displayed.
- For some titles, selection can be made using the DVD menu. In these cases, press **MENU** to display the DVD menu screen and then make your selection.

Changing Audio Type – Video CD/CD

For enjoyment of karaoke or similar format Video CDs and CDs, it is possible to select stereo audio, or either right or left channel mono depending on the requirements of the source.

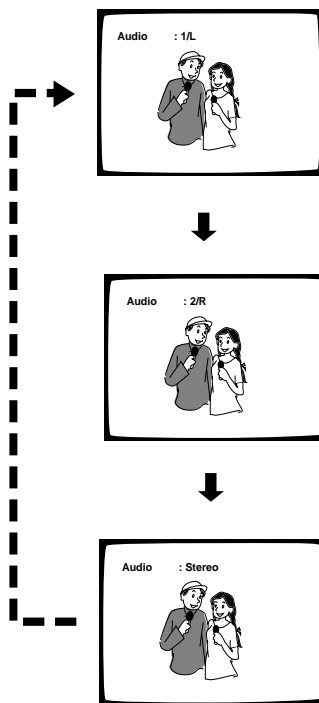

Press **AUDIO** repeatedly during playback to switch the audio type.

Audio output changes from “1/L” (Left channel) to “2/R” (Right channel) to “Stereo”.

Note

With karaoke and other discs, set the appropriate audio type for singing and accompaniment after referring to information on the disc jacket or accompanying material.

Setting Language and Subtitle Preferences in the Setup Screen Menus

The Setup screen **Language** menu contains a number of settings related to the audio and subtitle language preferences.

Selecting an audio language preference

The audio language that you normally listen to can be selected from the various audio languages on a DVD. Even when the audio language is changed during playback by pressing **AUDIO**, the language selected at this setting will be selected as the default when the DVD is changed.

Make changes to the [Audio Language] setting in the Setup screen **Language** menu.

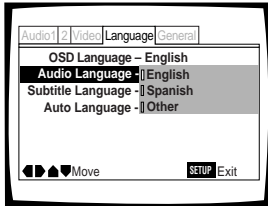

Settings: **English***

Spanish

Other (For details on how to select other languages, see 'When "Other" is selected' on the following page.)

*Factory setting

Note

The languages that can be selected may be different from those shown above.

Selecting a subtitle language preference

The subtitle language that you will normally display can be selected from the subtitles programmed on a disc. Even when the subtitle language is changed during playback by pressing **SUBTITLE**, the language selected at this setting will be selected when the disc is changed.

Make changes to the [Subtitle Language] setting in the Setup screen **Language** menu.

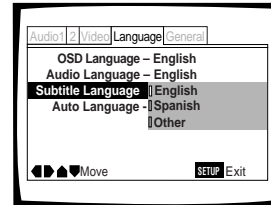

Settings: **English***

Spanish

Other (For details on how to select other languages, see 'When "Other" is selected' on the following page.)

*Factory setting

Note

The languages that can be selected may be different from those shown above.

When "Other" is selected

When you want to select one of the 136 languages as the main audio language, follow the steps below when the following screen appears.

A language code list can be found on page 51.

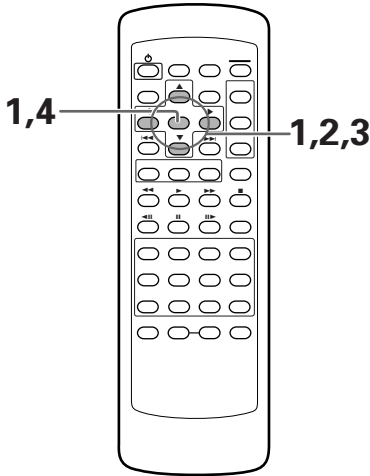
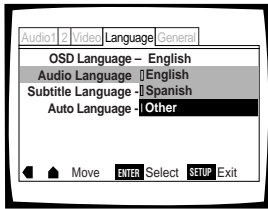

- 1 Use the cursor buttons to select "Other" and press **ENTER**.

The language selection screen appears.

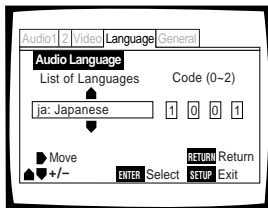

- 2 Use the cursor buttons (◀/▶) to select either "List of Languages" or "Code".

- 3 If you select "List of Languages", use the cursor buttons (▲/▼) to select the language.

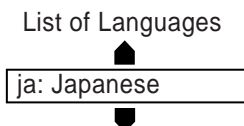

If you select "Code", use the cursor buttons (▲/▼) to input the numbers of the input code. Use the cursor buttons (◀/▶) to change the position of the cursor. You can also use the number buttons to enter the code.

Code (0~2)

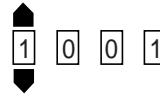

- 4 Press **ENTER** to set the new language. To exit the screen without making any changes, press **RETURN**.

Selecting a DVD menu language preference Expert

In addition to containing different audio languages, DVD may also contain menu screens in different languages as well. Setting a DVD language preference, sets the selected language as a default when DVDs with menu information in that language are encountered.

Selecting "w/ Subtitle Language" automatically assigns the language selected in the [Subtitle Language] setting.

Make changes to the [DVD Language] setting in the Setup screen **Language** menu in the "Expert" menu mode (page 20).

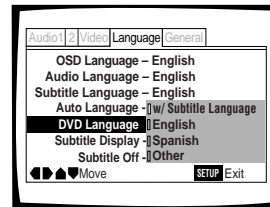

Setting: **w/ Subtitle Language***

English
Spanish
Other

* Factory setting

Notes

- The menu settings may look different from the one shown above.
- If this function is not effective, the languages that can be selected may also be selected in the DVD menu. Press **MENU** to open the DVD menu and make your selection accordingly.

Setting Auto Language to control subtitle and audio language based on program content

When the Auto Language function is used, foreign movies are shown with the original audio soundtrack and subtitles in the language selected in the [Subtitle Language] menu option. Domestic films are shown with the original audio soundtrack and no subtitles.

Make changes to the [Auto Language] setting in the Setup screen **Language** menu.

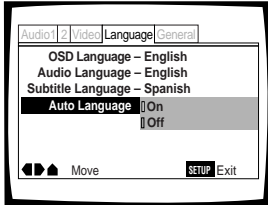

Settings: **On***
Off

* Factory setting

Note

The Auto Language function operates only when this function is set to "On", and the language set for the [Audio Language] and [Subtitle Language] settings is the same.

Selecting subtitles, assist subtitles or no subtitles Expert

Use this function to turn the subtitles on or off. Additionally, some DVDs provide assist subtitles that provide additional explanations of scenes in addition to the standard subtitles for viewers who are hard of hearing. Select "Assist Subtitle" to display these subtitles on DVDs where this function is offered.

Make changes to the [Subtitle Display] setting in the Setup screen **Language** menu in the "Expert" menu mode (page 20).

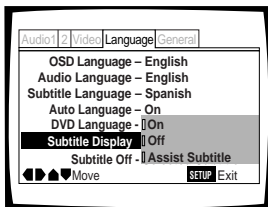

Settings: **On***
Off
Assist Subtitle

* Factory setting

Notes

- If there is no subtitle information recorded on the DVD, no subtitles are displayed even if this function is set to "On".
- This setting serves as a default as whether or not to display subtitles. Even if this option is set to "Off", subtitles can be displayed by pressing **SUBTITLE**. Similarly, if this option is set to "On", the subtitles can be turned off by pressing **SUBTITLE** and then **CLEAR**.

Selecting the language of forced subtitles Expert

Even when the subtitles are turned off, some DVDs will nevertheless display them on the screen. This setting allows you to select the language of the subtitles to be displayed with this type of DVD.

Select "With Audio" to display the subtitles in the same language as the currently selected audio language. Select "Selected Subtitle" to display the subtitles in the language set in the [Subtitle Language] setting.

Make changes to the [Subtitle Off] setting in the Setup screen **Language** menu in the "Expert" menu mode (page 20).

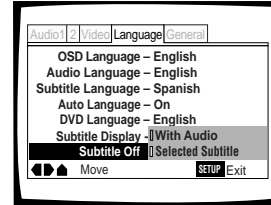

Settings: **With Audio**
Selected Subtitle*

* Factory setting

Advanced Functions

This player is compatible with DVD, Video CD, and CD disc formats. Users already familiar with Video CD or CD will already be familiar with some of the functions the player is capable of performing. With DVD, an even greater number of possibilities and functions are available.

In this section, you'll be able to:

- **Adjust the dynamic range of the audio soundtrack so that quiet sounds can be heard better (this page).**
- **Adjust the picture quality to better match program content (this page).**
- **Sing along with your favorite songs and other media with the player's karaoke function (DV-525K only)(page 34).**
- **Pause DVD or Video CD playback, play at extremely slow speeds or view frame by frame (page 35).**
- **Search for titles, chapters, tracks or locations on a disc (page 36).**
- **Change the angle of playback when viewing DVDs with multi-angle programming (page 37).**
- **Repeat an entire title, chapter, or track, or just a specified part (page 38).**
- **Play DVD titles or chapters, or Video CD/CD tracks in random order (page 39).**
- **Program DVD titles or chapters, or Video CD/CD tracks to play back in a specified order (page 40).**
- **Set the parental lock level to prevent children from having access to inappropriate material (page 43).**
- **Continue watching a DVD from where you left off using the Last Memory function (page 45).**
- **Save the system settings for up to 15 DVDs with the Condition Memory function (page 46).**
- **View playing time and other disc information (page 47).**
- **Change the background color (page 48).**
- **Reset the system (page 48).**

Note

DVDs differ in content and do not all contain the same information. Therefore some functions in this section may not work or have no effect on some DVDs.

Adjusting the Dynamic Range of the Audio Soundtrack – DVD

Audio DRC stands for Audio Dynamic Range Compression. When Audio DRC is on, soft sounds such as dialog can be heard more clearly without making loud sounds even louder. Select from three levels of compression depending on how much effect you want. When Audio DRC is set to "Off", there is no effect on the audio source.

Make changes to the [Audio DRC] setting in the Setup screen **Audio 2** menu.

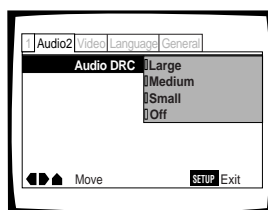

- Settings:
- Large**
(maximum compression of audio source)
 - Medium**
(moderate compression of audio source)
 - Small**
(very little compression of audio source)
 - Off***

*Factory setting

Note

Audio DRC is only effective with Dolby Digital audio sources.

Selecting Picture Quality Appropriate for Program Content – DVD/Video CD

This lets you select the ideal picture quality for watching movies, animation and other video media. Make changes to the [Picture Quality] setting in the Setup screen **Video** menu.

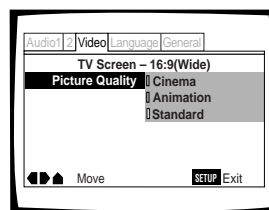

- Settings:
- Cinema**
Provides a sharp, clear black picture for images with high contrast.
 - Animation**
Provides images with bright clear colors.
 - Standard***
Presents the video with no effect added.

* Factory setting

Singing Your Favorite Songs Along with Karaoke Discs

– DVD/Video CD/CD (DV-525K only)

This player has a karaoke feature that lets you sing along with your favorite songs, featuring a microphone jack conveniently located on the front panel as well as controls for mixing the vocal level and amount of digital echo effect.

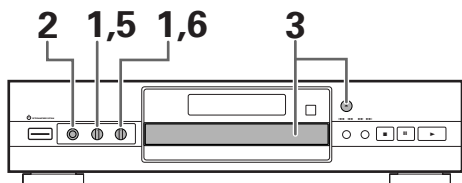

- 1 Turn both **VOLUME** and **ECHO** counterclockwise to the minimum level. To avoid possible damage to your speakers, be sure to turn down the volume completely before proceeding to step 2.

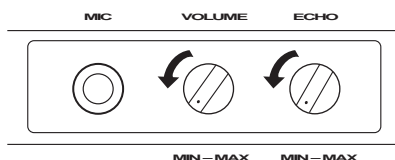

- 2 Connect a microphone (not supplied) to the MIC input jack. The karaoke function is active whenever a microphone is connected to the player. Make sure that the plug is inserted firmly and completely into the jack to use the karaoke function.

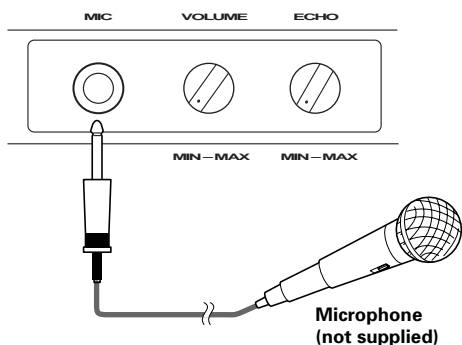

- 3 Load a disc with the music you want to use.

- 4 Play the title, chapter or track and adjust the volume of the audio playback.

- For more information on loading a disc and playing back a title, chapter or track, refer to the section "Getting Started Using Your DVD Player" starting on page 24.
- Adjust the volume on the TV or component that audio connections are made to. **VOLUME** on the front panel controls only the level of the microphone.

- 5 When the music starts, turn **VOLUME** clockwise while speaking or singing into the microphone to adjust the vocal volume to an appropriate level.

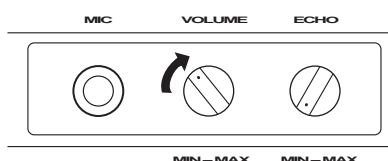

- 6 Turn **ECHO** clockwise to adjust the amount of echo effect that you want added to the vocals.

The amount of echo effect needed may differ for different styles of music and for different preferences.

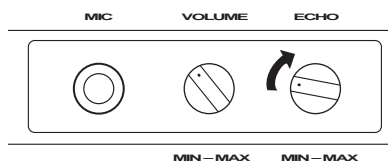

When "howling" occurs

If sound from the speakers is picked up by a mic and output again through the speakers, the result is a screeching sound known as "howling".

To eliminate howling:

- Point the mic away from the speakers.
- Move the mic away from the speakers.
- Turn **VOLUME** counterclockwise to lower the volume level.
- Turn **ECHO** counterclockwise to lower the echo effect.

Still Frame/Slow Play/Frame Advance Playback – DVD/Video CD

The video images on DVD and Video CD can be viewed as a still frame, played back at slow speeds and even advanced frame by frame.

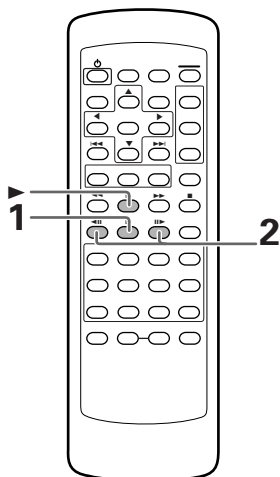

Viewing a still frame

Press **II** (pause).

When viewing a DVD, if the paused picture shakes, select the "Field" setting in the Setup screen **Video** menu [Still Picture] setting as described in the section below.

To return to normal playback

When viewing a still frame playback, pressing **II** (pause) or **▶** (play) restores normal playback operation.

Selecting the type of paused image to display Expert

This function lets you view a clear still-image when DVD playback is paused.

Make changes in the [Still Picture] setting in the Setup screen **Video** menu in the "Expert" menu mode (page 20).

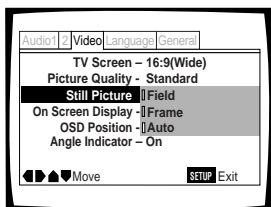

Settings: **Field** (Picture shake will be eliminated during a paused picture.)

Frame (Select to obtain higher picture quality.)

Auto* (Selects field or frame automatically according to the disc.)

* Factory setting

Viewing slow playback

Press and hold **STEP/SLOW II▶** during playback.

- Slow playback is engaged.
- During slow playback, the speed of playback can be adjusted from 1/2 normal playback speed to 1/16 normal playback speed in four steps using **STEP/SLOW ◀II** and **II▶**.

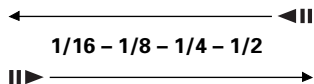

Press and hold **STEP/SLOW ◀II** during DVD playback.

- Slow playback in the reverse direction is engaged.
- In the reverse direction, the playback speed cannot be adjusted.

To return to normal playback

When viewing still frames or slow playback, pressing **▶** (play) restores normal playback operation.

Frame by frame advance playback: Viewing one frame at a time

1 Press **II** (pause).

2 Press **STEP/SLOW ◀II** or **II▶**.

STEP/SLOW II▶: The picture advances one frame each time the button is pressed.

STEP/SLOW ◀II: The picture backs up a DVD a few frames each time the button is pressed.

To return to normal playback

When viewing frame by frame playback, pressing **▶** (play) restores normal playback operation.

Notes

- There is no sound when viewing still frames or slow playback, or when advancing one frame at a time.
- Still frame, slow play, or frame advance playback may not be possible with certain titles. In this case, the mark is displayed.

Searching for a Title, Chapter, Track, or Location on a Disc

– DVD/Video CD/CD

This player offers different ways of accessing the information on a DVD, Video CD, or CD. Using **SEARCH MODE**, you can search for titles or chapters on a DVD, tracks on a Video CD or CD, and even select the point in time to start playback.

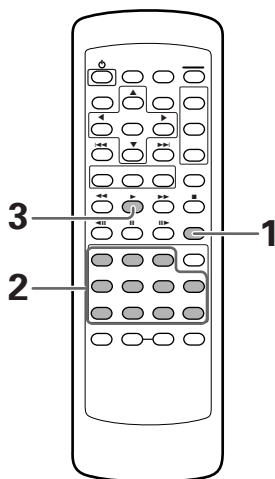

Notes

- For some discs, selection can be made using the top menu on the DVD. In this case, press **TOP MENU** to display the menu screen and then make your selection.
- With some DVDs, the search operation may not be possible and may stop shortly after being performed. In this case, the  mark is displayed.
- Time search is not possible with CDs.
- When performing DVD time search, playback may start from a slightly different time than that specified.
- Time search is not possible during when the disc is stopped.
- Search using time search is not possible during PBC playback of Video CDs.

To perform a direct title or chapter/track search using the number buttons

- Press the number buttons while the disc is stopped to select a title number.
- Press the number buttons while the disc is playing to select a chapter or track.

Note

Direct search cannot be performed for title, chapter, or track numbers 20 or higher. To search for titles, chapters, or tracks with numbers 20 or higher, use the title or chapter/track search procedures using **SEARCH MODE** as described on this page.

- 1 Press **SEARCH MODE** repeatedly to select the type of search.

The type of search changes which each press as follows.

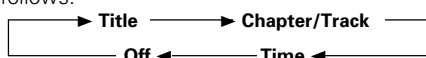

- 2 Press the number button(s) of the desired title, chapter or track or of the specific time where you would like to begin playback.

- To select number 3, press 3.
- To select number 10, press 1 and 0
- To select number 87, press 8 and 7.

When performing a time search:

- To select 21 minutes, 43 seconds, press 2, 1, 4, and 3.
- To select 1 hour, 14 minutes, press 7, 4, 0, and 0.

- 3 Press **▶ (play)**.

Playback of the selected title, chapter or track starts. When a time search is performed, playback begins at the appointed time.

Viewing from a Desired Camera Angle (Multi-Angle)

– DVD

You can select a camera angle when viewing DVDs with the multi-angle option.

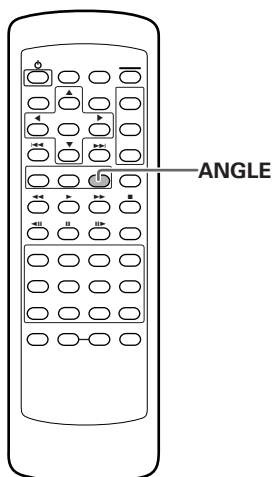
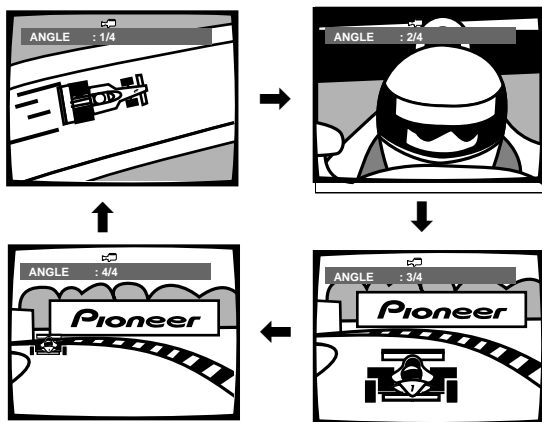

Press **ANGLE** during playback.

The camera angle changes each time you press the button.

Notes

- You can use the Multi-Angle function only with discs featuring recordings of images shot from different camera angles.
- During Multi-Angle playback, the ANGLE indicator in the display lights.
- For some discs, selection can be made using the DVD menu. In this case, press **MENU** to display the DVD menu screen and then make your selection.

To check whether or not a disc is recorded with angles:

The jacket of discs that are recorded with angles will be marked with . When locations on discs that are recorded with angles are played back, the indicator can be displayed.

To cancel the angle mark, set [Angle Indicator] to "Off" in the Setup screen **Video** menu described in the section below.

Turning the angle indicator on and off **Expert**

When a picture recorded in different angles is played back is displayed on the screen. This setting lets you see clearly whether the playback picture is recorded in multiple angles or not.

Turn the angle indicator on or off in the [Angle Indicator] setting in the Setup screen **Video** menu in the "Expert" menu mode (page 20).

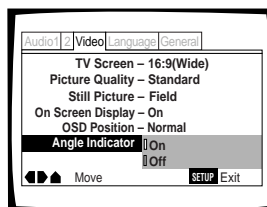

Settings: **On*** (is displayed)

Off (Not Displayed)

* Factory setting

Note

Even when the [Angle Indicator] setting is set to "Off", the ANGLE indicator in the display panel of the player lights during multi-angle playback. Therefore, it is possible to know when the multi-angle function can be used without having to display the icon on the screen.

Repeat Play – DVD/Video CD/CD

You can repeat an entire title, chapter or track, or just a part.

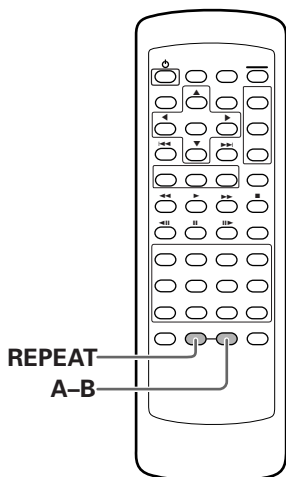

Repeat play of a chapter/track

Press **REPEAT** once during playback of the chapter or track you want to repeat.

Repeat play of a title

Press **REPEAT** twice during playback of the title you want to repeat.

- With DVDs, the title continues playing until the end, and then playback starts once more from the beginning of that title.
- With Video CDs and CDs, a disc is considered a single title, so the entire disc is repeated.

To repeat a program

Press **REPEAT** once during program playback to repeat the program.

To cancel repeat play

Press **CLEAR**. Playback continues, but the repeat function is canceled.

Repeat play of a specified section

Press **A-B** at the beginning and end of the section you want to repeat.

- When **A-B** is pressed a second time, the disc returns to the location where **A-B** was pressed first and plays the selected section repeatedly.
- You can only perform A-B repeat within the same title, chapter, or track.

To cancel A-B repeat play

Press **CLEAR**. Playback continues, but the repeat function is canceled.

Return to a specified location on a disc

- 1 Press **A-B** at the desired location.
- 2 When you want to return to the specified location, press **▶ (play)**.

To clear the specified location

Press **CLEAR** to cancel repeat play or to clear the specified location that was set using **A-B**.

Notes

- With some DVD discs, there may be times when repeat playback is not possible. In these cases, the  mark will appear on the screen.
- With Video CDs, repeat play is not possible when the menu is displayed (PBC playback). To perform repeat play, start playback without displaying a menu by pressing the track number to be repeated when the disc is stopped, and then press **REPEAT**.

Random Play – DVD/Video CD/CD

Play titles, chapters, or tracks on a disc in random order.

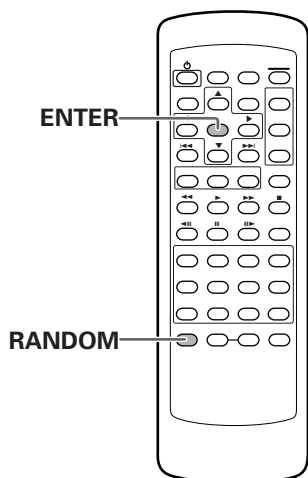

To change titles, chapters, or tracks during random play

- Press **▶▶ (next)** and the next randomly selected track starts playing.
- Press **◀◀ (previous)** and playback of the current track starts again from the beginning.

To stop random play

Press **CLEAR**. This returns you to normal playback of chapters/tracks in order from the chapter/track currently playing.

Notes

- With Video CDs, random play is not possible during playback when the menu is displayed (PBC playback). To perform random play, start playback without displaying a menu by pressing a track number button while in the stop mode, and then press **RANDOM**.
- Random play of programmed chapters/tracks is not possible.
- In the case of DVDs, random playback may not be possible with some discs.
- Repeat playback of random playback is not possible. In these cases, the  mark will appear on the screen.

Random playback of chapters within one title – DVD

Press **RANDOM** once, then press **ENTER**.

“Random Chapter” appears on the screen, and chapters within the title will be played back in random order.

Random playback of titles

Press **RANDOM** twice, then press **ENTER**.

“Random Title” appears on the screen, and titles will be played back in random order.

Random playback of tracks

–Video CD/CD

Press **RANDOM**.

“Random” appears on the screen, and random playback begins.

Playback in a Desired Order (Program Play) – DVD/Video CD/CD

The titles and chapters within a title on a DVD and similarly the tracks on a Video CD or CD can be arranged to play in the order you want.

Programming DVDs

A program with a maximum of 24 steps can be memorized.

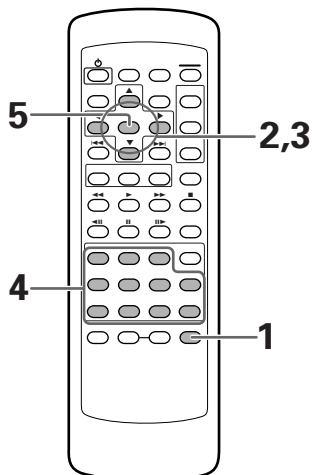

1 Press **PROGRAM**.

The Program screen appears.

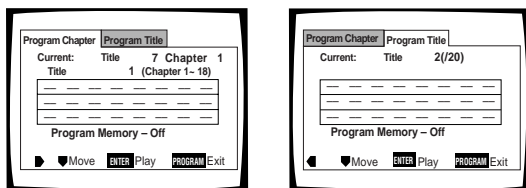

2 Use the cursor buttons (◀/▶) to select either Chapter or Title program.

3 Once the program type is selected. Use the cursor button (▼) to enter the program window.

When "Program Chapter" is selected, you must also select what title the chapters to be programmed are in. Use the cursor button (▲) to highlight "Title" and then use the number buttons to enter the title number to be used.

4 In the program window, use the number buttons to enter the numbers of the titles or chapters in the order you want to program them in.

- To program DVD titles/chapters 9, 7, and 18 in order, press 9, 7, +10 and 8.

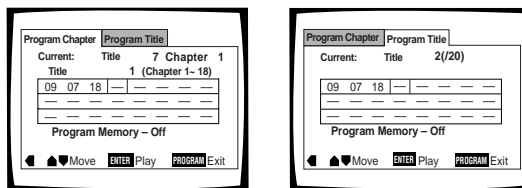

5 Press **ENTER**.

- Playback starts in the set order.
- Press **PROGRAM** to return to the previous display. The program will not begin until ► (play) is pressed.

To program a pause in a program

Press **II** (pause) instead of a number button.

"II" appears on the screen and the pause can be programmed.

A pause cannot be programmed as the first or last position in a program, and two or more pauses cannot be programmed in succession.

To delete a number:

Use the cursor buttons (▲/▼/◀/▶) to highlight the incorrect number and then press **CLEAR**.

The number is deleted. If the number was before another number, the later numbers are reordered automatically.

To insert a number:

Use the cursor buttons (▲/▼/◀/▶) to highlight the number to be placed after the new number and then press the number button(s) of the number to be inserted.

The new number is inserted before the previously selected number.

To stop program play

Press **■** (stop).

Notes

- When programming chapters, chapters not programmed may appear on the screen. This is not a malfunction.
- Programming may not be possible with certain DVD discs. On these types of discs, the mark will appear on the screen when programming is attempted.
- Only chapters within the same title can be programmed during chapter programming.

Programming Video CDs, CDs

A program with a maximum of 24 steps can be memorized.

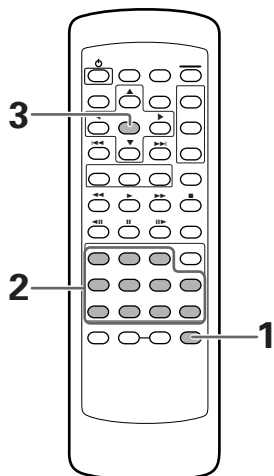

1 Press **PROGRAM**.

The program screen appears. When a Video CD or CD is loaded, the cursor appears in the program window.

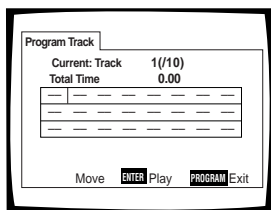

2 Use the number buttons to enter the numbers of the tracks in the order you want to program them in.

- To program tracks 9, 7, and 18 in order, press 9, 7, +10 and 8.
- To edit the program, refer to the procedures on the previous page.

3 Press **ENTER**.

- Playback starts in the specified track order.
- To stop the program play, press ■ (**stop**).

Notes

- To program a pause, or to add or delete a number, refer to the procedures for programming DVDs on page 40.
- You cannot program when playing a Video CD using menu selections (during PBC).

Additional programming options

– DVD/Video CD/CD

After you have made a program, it is then possible to confirm, add, or clear the contents of the program.

To confirm the contents of a program:

On a Video CD or CD track program, press **PROGRAM** to confirm. The program screen displays the current program.

On a DVD, select the program type (title or chapter) with the cursor buttons (◀/▶). The current DVD title or chapter program can then be confirmed on the appropriate program screen.

To add to a program:

- 1 Press **PROGRAM**.
- 2 Press a number button to add a new title, chapter, or track at the end of the program.
- 3 Press **PROGRAM** to exit the program screen.

To delete a program:

- 1 Press **PROGRAM**.
- 2 Select the program with the cursor buttons (◀/▶), then press **CLEAR**.
- 3 Press **PROGRAM** to exit the program screen.

Notes

- The complete program will be deleted even if the disc tray is open.
- Pressing **CLEAR** when the disc is stopped will clear all programs.

To make a program of your favorite parts of a disc as it plays – DVD/Video CD/CD

With this player, it is possible to make a program as you watch a DVD or Video CD or while listening to a CD.

Press and hold **PROGRAM** for at least 2 seconds at any point during playback of a title, chapter, or track you want to program, and it will be made into or added to a program without displaying a Program screen. When a title, chapter, or track is successfully added to the program, it is shown momentarily in the display as well as its position in the program.

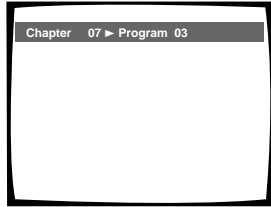

To confirm the contents of a program:

Press **PROGRAM**.

Notes

- When using this function to program DVDs, the program being created corresponds to the Program screen (chapter or title) that appears when **PROGRAM** is pressed. Be sure to check that the appropriate program type is selected.
- You cannot make a program containing chapters in different titles.

To save a program in memory – DVD

This player can memorize the programs on up to 24 DVDs. By turning the Program Memory to "On", the player will save your program and recall it the next time you use the same DVD. When the program memory exceeds 24, programs will be erased in chronological order from the oldest program in memory.

- 1 Use the cursor button (▼) to highlight [Program Memory] and use the cursor button (▶) to select "On".

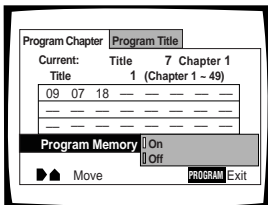

- 2 Press **ENTER**.

The program is saved in memory.

Note

When a DVD with a program stored in memory is loaded, program playback may start automatically.

To erase a program saved in memory – DVD

The player erases programs in chronological order when the maximum number of programs that can be held in memory is exceeded. To prevent the player from erasing older programs that you may still use regularly, or when you don't want to use a program anymore, it is possible to manually erase programs stored in memory.

- 1 Load a DVD that has a program stored in memory.
- 2 Press **PROGRAM**.
The program screen appears.
- 3 Use the cursor button (▼) to highlight [Program Memory] and use the cursor buttons (▶/▼) to select "Off".
- 4 Press **ENTER**.
The program is cleared from memory.

Setting the Parental Lock Level

This player lets you set the Parental Lock if the DVD has a parental lock level recorded on it. With Parental Lock capable discs, you can block access to material you feel is inappropriate for your children. Refer to the DVD disc jacket and the accompanying documentation to see if a particular disc contains a parental lock level.

Make changes to the [Parental Lock] setting in the Setup screen **General** menu. Please note that changes to the Parental Lock level can only be made when the player is stopped.

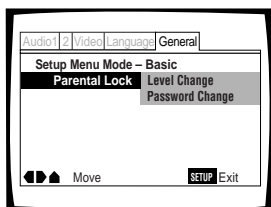

Settings: **Level Change** (For information, refer to "Setting the Parental Lock level" on the following page.)

Password Change (For information, refer to "Changing the password" on the following page.)

When a DVD with a set Parental Lock level is loaded

Playback cannot be started until the code number has been correctly input by using the cursor buttons (◀/▶/▲/▼) or the number buttons, and **ENTER** has been pressed.

Entering the password

When you select either "Level Change" or "Password Change", it is necessary to enter the password (4-digit code number). Use the following steps at any time you are asked to enter or confirm your password.

- 1 Use the cursor buttons (▲/▼) or the number buttons to select a number between 0 and 9. You can also use the number buttons to enter the numbers directly. When entering your password for the first time, or changing it, you will be asked to reenter your password. When using the number buttons to confirm the password, the numbers appear as asterisks, and the cursor advances automatically to the next position.

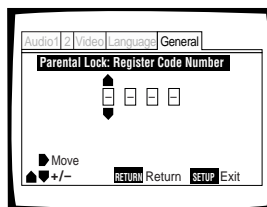

- 2 Use the cursor buttons (◀/▶) to move the cursor to a different position in the password. When all four numbers of the password have been entered, ENTER appears on the screen.

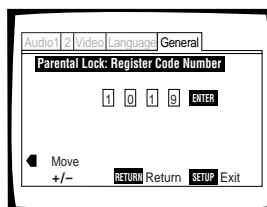

- 3 Press **ENTER** to set the new password. The password is entered.

Note

Be sure not to forget your password. If you should forget it, reset the system, and enter a new password. To reset the system, see 'Resetting the Player to System Settings' (page 48). Please note that this procedure resets the system, and clears all saved settings, not just the password.

Setting the Parental Lock level

Change the Parental Lock level to a higher or lower level according to the settings printed on the DVD disc jacket or accompanying documentation. If you use the Condition Memory function to save the settings for a particular disc, the Parental Lock level is saved as well. Because it is saved in memory, Parental Lock levels can be set for individual discs according to their content rather than a set level for all DVDs.

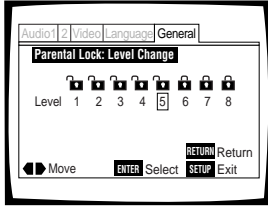

- 1 Select "Level Change" in the [Parental Lock] setting and press **ENTER**.
The screen changes to the password input screen. If you have not yet set a password, you will be asked to do so at this time. To enter the password, refer to "Entering the password" on the previous page.
- 2 Use the cursor buttons (◀/▶) to adjust the Parental Lock level.
The lock icons appear "unlocked" up to the selected level to indicate that access is available.
- 3 Press **ENTER** to set the new level.
The new Parental Lock level is set and the screen returns to the **General** menu screen. To go back to the **General** menu screen without making any changes, press **RETURN**.

Changing the password

Change your password whenever you feel it is necessary. However, if you forget your existing password, you cannot enter this screen to change it.

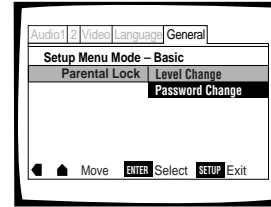

- 1 Select "Password Change" in the [Parental Lock] setting and press **ENTER**.
The screen changes to the password input screen as shown in the section 'Entering the password' on the previous page.
- 2 Enter your current password.
To enter the password, refer to 'Entering the password' on the previous page. If you have not yet set a password, you cannot select this setting. Establish a password by selecting "Level Change" first.
- 3 Use the cursor buttons (◀/▶/▲/▼) or the number buttons to enter the new password.
- 4 When the new password has been entered, press **ENTER**.
The new password is set and the screen returns to the **General** menu screen. To go back to the **General** menu screen without making any changes, press **RETURN**.

Continuing Playback from a Specified Location (Last Memory) – DVD/Video CD

The Last Memory function is convenient when you want to continue viewing a disc from the point where you were watching before. Unlike the resume function, the Last Memory function is effective even if the DVD is removed from the player (Last Memory locations saved for Video CDs are effective only if the disc remains loaded in the player).

Memorizing a Last Memory location to return to later

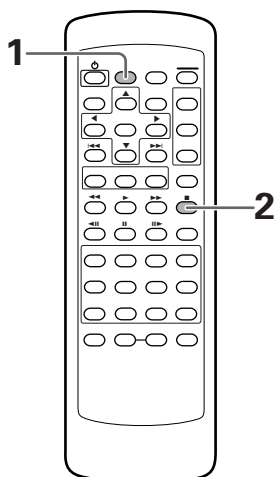

1 Press **LAST MEMORY** during play.
The LAST MEMO indicator lights on the player.

2 Press **⏻** to turn the power to standby, or stop playback with **■ (stop)**.

Once memorized, the memorized point will be recalled even if the power is turned off, or if the disc is ejected. Points on up to 5 discs can be memorized, and those points are recalled the next time any of the discs are played back.

- A Last Memory point can be memorized for only one Video CD at a time as the function is only effective until the Video CD is removed from the player.

Resuming playback from where LAST MEMORY was pressed

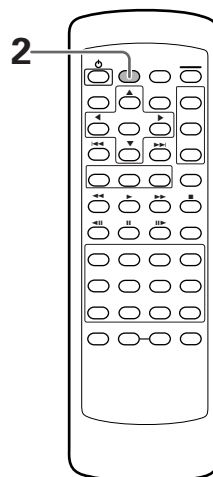

1 Load a disc that has a Last Memory point memorized.
Some DVDs will start playback automatically when loaded. In this case, press **■ (stop)** to stop playback.

2 Press **LAST MEMORY** while in the stop mode.
The disc begins playback at the memorized point.

- Last Memory mode may not function for some DVDs.
- If you register more than five DVDs, details of the latest disc are memorized, while details of the least recent disc (the disc you registered first) is erased.
- Even with a disc you have memorized with Last Memory, playback begins at the start of the disc if you press **▶ (play)**.
- This function is for playback of DVDs only. You cannot use it with Video CDs or CDs.

To clear the Last Memory location

Call up the Last Memory location by pressing **LAST MEMORY**. Then press **CLEAR** while "Last Memory" is still being displayed on the screen.

The LAST MEMO indicator disappears from the display.

Memorizing Settings for Often Viewed DVDs (Condition Memory) – DVD

You can store in memory settings for DVDs you often watch. Settings remain in memory even if you remove the disc from the player, or switch power to the player to standby. If you load a disc that has its settings memorized, "COND_MEMO" appears in the display. When you start playing the disc, the memorized settings are automatically recalled.

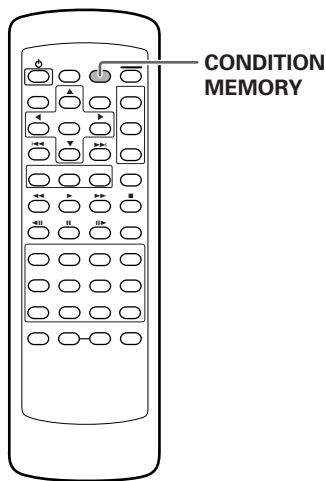

When a disc that has memorized settings is loaded

"Condition Memory" will appear on the screen, and the previously memorized settings will be selected.

Erasing the recorded contents

Load a disc that has memorized settings, and press **CLEAR** while "Condition Memory" is being displayed. The disc's recorded data will be erased.

Notes

- Settings are stored in memory for use any time.
- You can store settings for up to 15 DVDs in memory. If you memorize settings for more than 15 DVDs, previously memorized settings are erased in chronological order from the least recently memorized. Subsequently, if you load a disc with erased settings, the settings of the most recently played disc are used.
- If you make changes to any of the settings memorized in Condition Memory, press **CONDITION MEMORY** during playback to memorize new settings.
- Switching of the multi-language mode etc., is automatic on some discs.

Press **CONDITION MEMORY** during playback.

Settings are memorized for the disc currently playing.

The following six settings are memorized:

TV Screen (page 22)

OSD Position (page 23)

Multi-Language subtitles (page 28)

Multi-language (page 29)

Multi-Angle (page 37)

Parental Lock Level (page 43)

Viewing Disc Information

– DVD/Video CD/CD

Use **DISPLAY** to get current information about the disc currently loaded. You can get information about the titles and chapters on a DVD or tracks on a Video CD or CD. When viewing DVDs, you can also check the digital bitstream transmission rate.

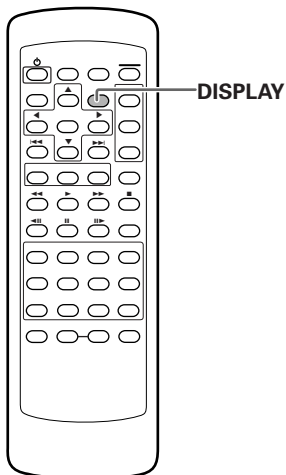

Press **DISPLAY** during while a disc is playing. Press **DISPLAY** repeatedly to change the information being displayed.

The disc information is displayed superimposed over the video image on the screen.

Note

Depending on the format and type of disc being used, not all screens may be displayed.

The display changes for each type of disc as follows each time the button is pressed.

DVD

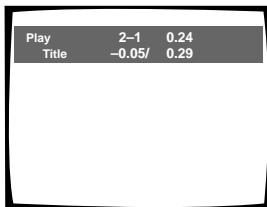

TITLE information:

Top Row: title and chapter number, elapsed time of current title

Bottom Row: remaining time in title, total time of title

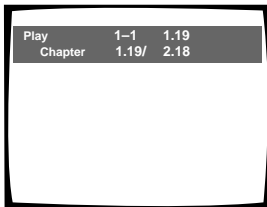

CHAPTER information:

Top Row: title and chapter number, elapsed time of current title

Bottom Row: time in current chapter, total time of chapter

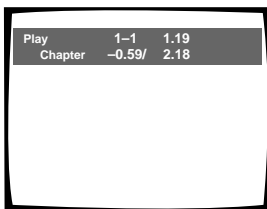

CHAPTER information:

Top Row: title and chapter number, elapsed time of current title

Bottom Row: remaining time in current chapter, total time of chapter

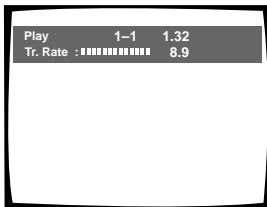

Data transmission rate information:

Top Row: title and chapter number, total elapsed time of DVD

Bottom Row: bitstream transmission rate level



Display off

CD



Track Information:

Top Row: current track number, track time

Bottom Row: remaining time of current track, and total time of track

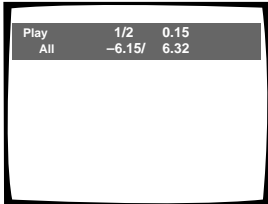

Disc information:

Top Row: current track number, total number of tracks on CD, total elapsed time of CD

Bottom Row: remaining time of CD, total time of CD



Display off

Video CD (with PBC disabled)

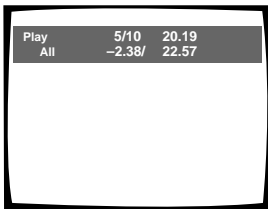

Disc information:

Top Row: current track number, total number of tracks, total elapsed time of Video CD

Bottom Row: remaining time of Video CD, total time of Video CD

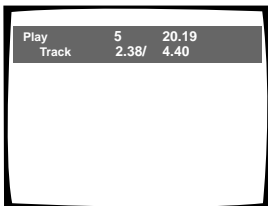

Track information:

Top Row: current track number, total elapsed time of Video CD

Bottom Row: track time, total time of track



Track information:

Top Row: current track number, total elapsed time of Video CD

Bottom Row: remaining time of track, total time of track



Display off

Press **DISPLAY** during while a disc is stopped to display DVD title and chapter information or Video CD and CD track information. Press **DISPLAY** again to turn the display off.

Information about the titles and chapters or tracks on a disc is displayed. When the information exceeds the space on the screen, use the cursor buttons (◀/▶) to move to other screens.

DVD

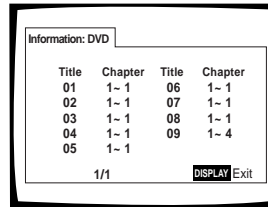

DVD information

When a DVD is loaded, each title and the number of chapters within each title is displayed.

Video CD and CD

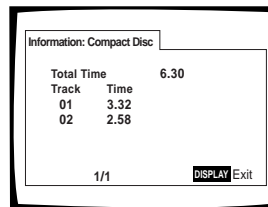

Video CD and CD information

When a Video CD or CD is loaded, the total time of the disc and the time of each track on the disc is displayed.

Changing the Background Color of the Screen Expert

You can select a blue or black background to appear when the player is in the stop mode.

Make changes to the [Background Color] setting in the Setup screen **General** menu in the "Expert" menu mode (page 20).

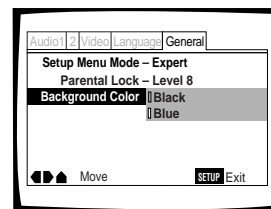

Settings: **Black**
Blue*

*Factory setting

Resetting the Player to System Settings

To reset the player, press and hold **■ (stop)** on the main unit when pressing **POWER** to turn the unit from off to on .

All program memory, saved settings from functions such as Last Memory and Condition Memory are cleared, and all Setup screen menus are returned to factory settings.

Additional Information

Disc Care

HOW TO HOLD DISCS

When loading or removing discs, try not to touch their playing surfaces.



CLEANING

Fingerprints or other dirt on the disc may affect sound and picture quality.

To clean your discs, use a soft clean cloth to wipe them. If necessary, moisten a soft cloth with diluted neutral detergent to remove heavy dirt or fingerprints.



Do not wipe in a circular direction (Concentric scratches in the disc groove tend to cause noise.)

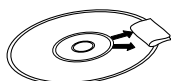

Gently wipe from the inside toward the outer edge.

Discs must not be cleaned with record cleaning sprays, or static prevention sprays, etc. Also do not use volatile liquids such as benzine, or thinner, etc.

LENS CLEANER

The player's pickup lens should not become dirty in normal use, but if for some reason it should malfunction due to soiling, contact your nearest PIONEER authorized service center. Lens cleaners are commercially available, but special care should be exercised in their use since some may cause damage to the lens.

NEVER PLAY CRACKED OR WARPED DISCS

The disc revolves in the player at high speed when it is played. Never play a cracked, scratched or warped disc. This may damage the player or cause it to malfunction.

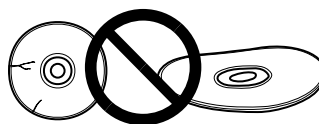

NEVER USE DISCS WITH SPECIAL SHAPES

CD's with special shapes (heart-shaped CDs, octagonal CDs, etc.) cannot be played on this set.

Attempting to do so may damage the set. Do not use such CDs.



AFTER USING DISCS, STORE THEM UPRIGHT

After playing a disc, always remove it from the player and return it to its jacket. Then store it standing upright away from heat and humidity.

- Store discs carefully. If you store discs at an angle, or stacked on top of each other, discs may become warped even when in their jackets.
- Do not leave discs in locations such as the seat of a car, which may become excessively hot.

CAUTION WHEN USING THE DISC

All rights reserved.

Unauthorized public performance, broadcasting or copying is a violation of applicable laws.

Notes on using optical cables

- Do not route cords around sharp angles. When storing, wind the cords so that they have a diameter of at least 15 cm.
- When connecting, push all the way into the terminal.
- Do not use cords with a length of over 3 m.
- If moisture or dust has collected on the plug, wipe it with a soft cloth before connecting.

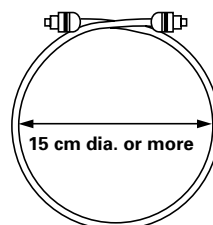

For Proper and Long Use of This Unit

DO NOT MOVE THE UNIT DURING PLAYBACK

During playback, the disc rotates at high speed. Do NOT lift or move the unit during playback. Doing so may damage the disc.

WHEN MOVING THE UNIT

When changing places of installation or packing the unit for moving, be sure to remove the disc and return the disc table to its original position in the player. Turn off the player and unplug the power cord from the wall outlet in a manner appropriate for your player model as follows.

With the **DV-525K**, press **⏻ STANDBY/ON** to switch the power to standby. **Check that the “-OFF-” indication in the display goes off**, then disconnect the power cord.

With the **DV-525**, press **⏻ STANDBY/ON** on the remote control to switch the power to standby **checking that the “-OFF-” indication in the display goes off**. Press **POWER** on the front panel to turn the player off, and then disconnect the power cord.

Moving this unit with the disc loaded may result in damage to this unit.

INSTALLATION

- Select a stable place to the side of a TV set or stereo system to be connected to the unit.
- When using the unit with a stereo system, install the speakers a little bit away from the TV.
- Do NOT install the unit on top of a TV or color monitor. Install the unit away from equipment that may be affected by magnetism, such as a cassette deck.
- Do NOT place objects on top of the unit.

AVOID INSTALLING IN A PLACE THAT IS:

- Exposed to direct sunlight
- Exposed to humidity or where ventilation is poor
- Extremely hot or cold
- Exposed to vibration
- Exposed to dust
- Exposed to oily smoke, steam or heat (for example, a kitchen)

DO NOT BLOCK VENTS

Do NOT use the player on top of a long-fibered carpet, bed or sofa, and do not cover it with a cloth, etc. This will prevent heat radiation and could result in damage.

AVOID HEAT

Do NOT place the unit on equipment which generates heat, such as an amplifier.

When installing the unit in a rack, place it on the lowest shelf possible (however, not where it is exposed to dust) and separated from the amplifier to avoid the heat generated by the amplifier or other audio equipment.

CONDENSATION

Moisture may form in the operating section of the player if the player is brought from cool surroundings into a warm room or if the temperature of the room rises suddenly. When this happens, the player's performance will be impaired.

To prevent this, let the player stand in its new surroundings for about an hour before switching it on, or make sure that the room temperature rises gradually.

Condensation may also form during the summer if the player is exposed to the breeze from an air conditioner. In such cases, change the location of the player.



SWITCH POWER TO STANDBY WHEN NOT USING THE UNIT

Depending on the strength of the TV or radio broadcast signal, having the TV or radio on while power to the unit is on may result in stripes on the TV screen or noise. However, this is not a malfunction of this unit or the TV or radio. In such a case, switch the power of the unit to standby.

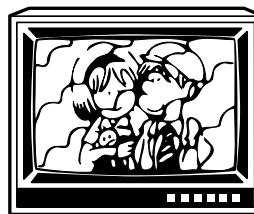

POWER-CORD CAUTION

Handle the power cord by the plug. Do not pull out the plug by tugging the cord and never touch the power cord when your hands are wet as this could cause a short circuit or electric shock. Do not place the unit, a piece of furniture, etc., on the power cord, or pinch the cord. Never make a knot in the cord or tie it with other cords. The power cords should be routed in such a way that they are not likely to be stepped on. A damaged power cord can cause a fire or give you an electrical shock. Check the power cord once in a while. When you find it damaged, ask your nearest PIONEER authorized service center or your dealer for a replacement.

CAUTION: WHEN PLACING THE UNIT IN A STEREO RACK WITH GLASS DOORS

Be sure there is ample space between the unit and the glass doors when opening the disc table using the remote control. If the disc table opens against strong resistance, such as a closed glass door, damage to the unit may result.

Language Code List

Language codes are used when setting the audio and subtitle language preferences. (See page 30)

Language	Input-code
Japanese (ja)	1001
English (en)	0514
French (fr)	0618
German (de)	0405
Italian (it)	0920
Spanish (es)	0519
Dutch (nl)	1412
Russian (ru)	1821
Chinese (zh)	2608
Korean (ko)	1115
Greek (el)	0512
Afar (aa)	0101
Abkhazian (ab)	0102
Afrikaans (af)	0106
Amharic (am)	0113
Arabic (ar)	0118
Assamese (as)	0119
Aymara (ay)	0125
Azerbaijani (az)	0126
Bashkir (ba)	0201
Byelorussian (be)	0205
Bulgarian (bg)	0207
Bihari (bh)	0208
Bislama (bi)	0209
Bengali (bn)	0214
Tibetan (bo)	0215
Breton (br)	0218
Catalan (ca)	0301
Corsican (co)	0315
Czech (cs)	0319
Welsh (cy)	0325
Danish (da)	0401
Bhutani (dz)	0426
Esperanto (eo)	0515
Estonian (et)	0520
Basque (eu)	0521
Persian (fa)	0601
Finnish (fi)	0609
Fiji (fj)	0610
Faroese (fo)	0615
Frisian (fy)	0625
Irish (ga)	0701
Scots-Gaelic (gd)	0704
Galician (gl)	0712
Guarani (gn)	0714
Gujarati (gu)	0721
Hausa (ha)	0801

Language	Input-code
Hindi (hi)	0809
Croatian (hr)	0818
Hungarian (hu)	0821
Armenian (hy)	0825
Interlingua (ia)	0901
Interlingue (ie)	0905
Inupiak (ik)	0911
Indonesian (in)	0914
Icelandic (is)	0919
Hebrew (iw)	0923
Yiddish (ji)	1009
Javanese (jw)	1023
Georgian (ka)	1101
Kazakh (kk)	1111
Greenlandic (kl)	1112
Cambodian (km)	1113
Kannada (kn)	1114
Kashmiri (ks)	1119
Kurdish (ku)	1121
Kirghiz (ky)	1125
Latin (la)	1201
Lingala (ln)	1214
Laothian (lo)	1215
Lithuanian (lt)	1220
Latvian (lv)	1222
Malagasy (mg)	1307
Maori (mi)	1309
Macedonian (mk)	1311
Malayalam (ml)	1312
Mongolian (mn)	1314
Moldavian (mo)	1315
Marathi (mr)	1318
Malay (ms)	1319
Maltese (mt)	1320
Burmese (my)	1325
Nauru (na)	1401
Nepali (ne)	1405
Norwegian (no)	1415
Occitan (oc)	1503
Oromo (om)	1513
Oriya (or)	1518
Panjabi (pa)	1601
Polish (pl)	1612
Pashto, Pushto (ps)	1619
Portuguese (pt)	1620
Quechua (qu)	1721
Rhaeto-Romance (rm)	1813

Language	Input-code
Kirundi (rn)	1814
Romanian (ro)	1815
Kinyarwanda (rw)	1823
Sanskrit (sa)	1901
Sindhi (sd)	1904
Sangho (sg)	1907
Serbo-Croatian (sh)	1908
Singhalese (si)	1909
Slovak (sk)	1911
Slovenian (sl)	1912
Samoan (sm)	1913
Shona (sn)	1914
Somali (so)	1915
Albanian (sq)	1917
Serbian (sr)	1918
Siswati (ss)	1919
Sesotho (st)	1920
Sundanese (su)	1921
Swedish (sv)	1922
Swahili (sw)	1923
Tamil (ta)	2001
Telugu (te)	2005
Tajik (tg)	2007
Thai (th)	2008
Tigrinya (ti)	2009
Turkmen (tk)	2011
Tagalog (tl)	2012
Setswana (tn)	2014
Tonga (to)	2015
Turkish (tr)	2018
Tsonga (ts)	2019
Tatar (tt)	2020
Twi (tw)	2023
Ukrainian (uk)	2111
Urdu (ur)	2118
Uzbek (uz)	2126
Vietnamese (vi)	2209
Volapük (vo)	2215
Wolof (wo)	2315
Xhosa (xh)	2408
Yoruba (yo)	2515
Zulu (zu)	2621

Troubleshooting

Incorrect operations are often mistaken for trouble and malfunctions. If you think that there is something wrong with this component, check the points below. Sometimes the trouble may lie in another component. Inspect the other components and electrical appliances being used. If the trouble cannot be rectified even after exercising the checks listed below, ask your nearest PIONEER authorized service center or your dealer to carry out repair work.

The disc table comes back out automatically, shortly after the disc table is closed.

The disc is dirty or warped.

➔ Refer to "Disc Care" (page 49).

The disc is not placed properly on the disc table.

➔ Use the disc table guide to align the disc (page 24).

Region number does not conform with this unit.

➔ If the region number on the disc does not match the number on the player, the disc cannot be used (page 55).

There is condensation on the operating section of the player.

➔ Allow time for condensation to evaporate. If player is near an air conditioning unit, you should move the player (page 50).

Playback is not possible.

The disc has been loaded upside down.

➔ Check that the disc has been loaded with the label side facing up.

mark appears on screen.

The selected function does not operate for that disc.

mark appears on screen.

The operation is prohibited by the player.

Picture playback stops and the operation buttons cannot be used.

Player malfunctions.

➔ Press **■ (stop)** to stop disc playback, then start playback again.

New settings made in the Setup screen menus while a disc is playing are ineffective.

Some settings can be changed while a disc is playing, but are not effective. This is not a malfunction.

➔ Make the same setting when the player is stopped.

➔ Press **■ (stop)** to stop disc playback, then start playback again. When playback is resumed, the new settings should be in effect. Please note that making settings in the Setup screen menus may cancel the resume function.

When making changes in the Setup screen menus, is displayed.

There is a Video CD or CD loaded in the player and the setting that was changed only applies to DVD performance.

➔ The setting will be effective the next time a DVD is loaded.

Settings are canceled.

When the power is turned off by power failure or by unplugging the power cord, settings will be canceled.

➔ (DV-525K only) Before unplugging the power cord, press **⏻ STANDBY/ON** and check that "--OFF--" disappears in the display.

➔ (DV-525 only) Before unplugging the power cord, press **⏻ STANDBY/ON** checking that "--OFF--" disappears in the display, and then press **POWER** on the front panel.

No picture.

Connection is incorrect.

➔ Check that cord connections are correct and that plugs are firmly connected.

Operation (settings) of TV or AV amplifier is not appropriate.

➔ Be sure that your TV, receiver, or amplifier is set up to view DVD playback.

The screen is stretched or aspect does not change.

The multi aspect setting is not appropriate.

➔ Change the aspect setting in the [TV Screen] setting in the Setup screen **Video** menu to the screen type most appropriate to the TV or monitor you are using (page 22).

Picture disturbance during playback or dark.

This is not a malfunction.

➔ This player is compatible with Macro-Vision System copy guard. Some discs include a copy prevention signal, and when this type of disc is played back, stripes etc., may appear on some sections of the picture depending on the TV.

When recorded on a VCR or passed through an AV selector, there is disturbance in the playback picture.

This is not a malfunction.

➔ Due to the player's copy protection circuits, connection of this device through a VCR or an AV selector may prevent recording or cause picture problems.

Remote control operation is not possible.

The rear panel control input jack on the player is being used.

➔ Point the remote control at the component that the player is connected to (page 18).

The remote control is too far from the player, or the angle with the remote sensor is too wide.

➔ Be sure to operate the remote from a location within its operating range (page 9).

The batteries are exhausted.

➔ Replace the exhausted batteries with all new batteries (page 8).

Audio is not output or is distorted.

The Setup screen **Audio 1** menu [96 kHz PCM Out] setting is set to "96 kHz". Digital output is prohibited on some discs.

- ➔ Be sure to make analog audio connections as well as digital connections (pages 15 and 16).

The disc is dirty.

- ➔ Refer to "Disc Care" (page 49).

The connection plugs are not inserted fully into the terminals or are not connected.

- ➔ Check that all connection plugs are firmly inserted.

The connection plug or terminal is dirty.

- ➔ Check that the plugs and terminals are wiped clean of dirt, etc.

Audio cable connection is wrong.

- ➔ Check to make sure that the audio cables are connected correctly (page 16).

Connection is made to the stereo amplifier's PHONO input terminal.

- ➔ Change connection to any input terminal except PHONO.

The pause mode is engaged.

- ➔ Press ► **(play)** or II **(pause)** to exit the pause mode.

Stereo amplifier operation is incorrect.

- ➔ Check input (CD, AUX, etc.) selector to determine if it is selected for DVD playback.

The DVD or CD is recorded in DTS audio.

- ➔ DTS audio is only output from the digital output jacks. Connect the digital output on the player to the digital input on a receiver or amplifier with a built in DTS decoder to hear DTS audio.

Noticeable difference in DVD and CD volume.

DVDs and CDs use different recording methods.

- ➔ This is not a malfunction.

There is a howling or high-pitched sound from the speakers when using the karaoke function. (DV-525K only)

The mic is too close or pointing towards the speakers.

- ➔ Try to keep the mic pointed away from the speakers.

- ➔ Turn down the volume on the mic.

Karaoke functions are not possible. (DV-525K only)

A mic is not connected to the player or is not turned on.

- ➔ Check that a mic is connected to the player. If the mic has an on/off switch, check that the mic is switched on.

The mic volume is turned down all the way.

- ➔ Adjust the mic volume so that vocals can be heard.

Caution

Static electricity or other external influence may cause malfunctioning of this unit. In this case, unplugging the power cord and then re-plugging it in will usually reset the unit for proper operation. If this does not correct the problem, please consult your nearest PIONEER service center.

Terms

Aspect ratio

Aspect ratio refers to the length to height ratio of TV screens. The ratio of a standard TV is 4:3, while the ratio of a high-definition or wide TV is 16:9. The latter allows you to enjoy a picture with a wider perspective.

Chapter number

Chapter numbers are the numbers assigned to sections of a title on the disc, similar to chapters in a book. If the disc includes chapter numbers, you can locate the section you want very quickly using search and other functions.

Component (color difference) video output

The color signal of the TV is divided into the luminance (Y) signal and the color (P_B and P_R) signals and then output. In this way mutual interference of each signal is avoided. On a TV with component input jacks, these signals are synthesized to produce the picture.

Condition memory

“Condition” refers to the various mode settings, etc. On this player, various conditions, such as those set during playback, can be memorized. This function allows you to play back the same disc at any time without having to redo your preferred settings.

Digital bitstream

The bitstream does not refer to the audio signal, but rather to the digital data that, once converted, becomes the audio signal. The player outputs digital bitstreams via the digital optical or digital coaxial output. If the bitstream cannot be decoded by the connected AV amplifier etc., digital noise is produced. Digital bitstream formats compatible with different entertainment systems can be selected in the Setup screen **Audio 1** menu.

Digital output (Coaxial)

Output of the digital audio signal is transmitted electronically using a coaxial cable. Because the signal being transmitted is digital, connection must be made to the coaxial digital input of another component. Noise will be output if connected to the analog audio inputs as the digital signal cannot be decoded.

Digital output (Optical)

Normally, audio is converted to an electric signal and transmitted through an electric wire from the player to the amplifier, etc. Changing this signal to a digital signal and transmitting it through an fiber-optic cable is called optical digital output. Similarly, optical digital input receives digital signals from external units such as an AV amplifier or receiver.

Dolby Digital

The maximum 5.1 channels of audio used in the surround system (Surround Digital) for movie theaters is digital data compressed by the third generation algorithm encoder, AC-3.



In order to enjoy Dolby Digital discs, this unit's digital output jack (either coaxial or optical) must be connected to the digital input jack of an AV amplifier or Dolby Digital decoder to enjoy the sound of Dolby Digital soundtracks.

DTS

DTS stands for Digital Theater System. DTS is a surround system different from Dolby Digital that has become a popular surround sound format for movies. In order to enjoy the benefits of DTS encoded discs, the digital output jack (either coaxial or optical) of this player needs to be connected to an AV amplifier or receiver or to a DTS decoder to be able to enjoy the surround sound of DTS audio. DTS audio is not output from the analog audio outputs.

Dynamic range

Dynamic range refers to the difference between the maximum and minimum levels of the audio soundtrack as measured in decibels (dB).

Compressing the dynamic range raises the minimum signal level and lowers the maximum signal level. This allows you to hear voices and other low level audio signals clearly while lowering strong audio signals like the sound of explosions.

MPEG

Short for Moving Picture Experts Group. This is an international standard for compression of moving images. On some DVDs, digital audio has been compressed and recorded in this format.

Multi-angle

When you watch a TV program, you are watching the image filmed through the TV camera. Because of this, the picture is displayed on your TV from the viewpoint of the TV camera's position. In a TV studio, the image is filmed by many cameras at the same time, and one of those images is selected by the program director and transmitted to your TV. If all the filmed images were transmitted to your TV you would be able to select the camera image you want. Some DVD discs are recorded with the angles of more than one camera used for filming, and these can be selected using this player. These types of discs are called multi-angle discs.

Parental lock level

This function was suggested by parents concerned about what type of media their children were able to watch. Parental lock restrictions are restrictions incorporated into titles which include scenes that parents may not wish their children to view.

PCM

PCM stands for Pulse Code Modulation and is digital audio. The digital audio of CDs is PCM. This player also has a function that converts Dolby Digital and MPEG digital bitstreams into PCM to enable you to listen to quality digital sound even without a special decoder.

Playback Control (PBC)

This refers to signals recorded on a Video CD (Version 2.0) enabling playback control.

You can use menus recorded on discs with PBC for easy, interactive search for desired scenes, and playback.

You can also enjoy viewing high-resolution/standard resolution still images.

Regional restriction codes (region number)

Regional restriction codes are built in to DVD players and DVD discs for each sales region. If the regional code of the DVD player does not match one of the regional codes of the DVD disc, playback is not possible.

The region number can be found on the rear panel of the DVD player. The illustration below shows the regions and corresponding region numbers.

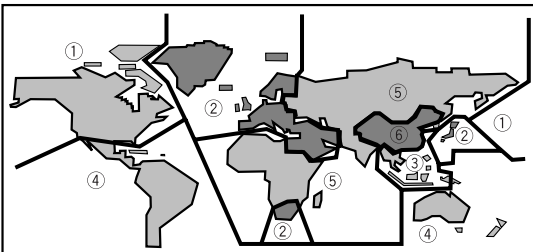

Sampling Frequency

When a sound wave is converted to a digital signal, the sound is sampled and converted to data at a specific frequency rate. For example, a signal with a 96 kHz sampling rate indicates that in one second, the analog signal was sampled 96000 times to produce the digital signal.

Subtitle

Subtitles are language titles superimposed on movies, or other media. Up to 32 different subtitle languages can be recorded on a DVD disc. The subtitle function can be used to select the language of your choice.

S-video

Connecting the S-video output on the player to a TV or monitor with S-video input via an S-video cable produces clearer picture reproduction by sending separate signals for the luminance and the color. These signals are then combined by the television to produce a better quality picture.

System control

When you connect this player via a cord with a mini plug to another Pioneer component such as a receiver or an amplifier bearing the **SR** mark, you can control the player as though it were a component in a system. To control the player, point the player's remote control at the component that the player is connected to, and not the player itself.

Time number

The time number corresponds to the elapsed playback time of a disc from its beginning. When using the time search function, use the time number to locate scenes that occur at the time selected.

Title number

DVD discs are divided into units referred to as titles, and titles are divided into chapters. Menu screens do not belong to any title. A disc which contains a movie may have only one title with many or no chapter divisions. Karaoke discs may have many titles, assigning a title to each song on the disc.

TOC

TOC (Table Of Contents) information is data other than audio signal data, recorded at the beginning of a disc. As the name implies, it's like the list of contents in a book, with information such as the number of songs and playback time.

Specifications

General

System ... DVD system and Compact Disc digital audio system

Power requirements

DV-525 (except for Taiwan model)
..... AC 110-127/ 220-240 V, 50/60 Hz
DV-525 (Taiwan model) AC 110 V, 60 Hz
DV-525K AC 110-127/ 220-240 V, 50/60 Hz

Power consumption

DV-525 13 W
DV-525K 14 W

Power consumption in standby mode

DV-525 (Taiwan model) 0.7 W
DV-525 (except for Taiwan model) and DV-525K 0.9 W

Weight 2.8 kg

Dimensions (Not including protruding cables, etc.)

DV-525 (except for Singapore and Malaysian models)
..... 420 (W) x 285 (D) x 104 (H) mm
DV-525 (Singapore and Malaysian models)
..... 420 (W) x 286 (D) x 104 (H) mm
DV-525K 420 (W) x 286 (D) x 104 (H) mm

Operating temperature +5°C to +35°C

Operating humidity 5% to 85% (no condensation)

S-Video output

Y (luminance) - Output level 1 V_{p-p} (75 Ω)

C (color) - Output level 286 mV_{p-p} (75 Ω)

Jacks S-VIDEO jack

Video output

Output level 1 V_{p-p} (75 Ω)

Jacks RCA jack

Component video output (DV-525 only)

(Y, P_B, P_R)

Output level Y: 1.0 V_{p-p} (75 Ω)

P_B, P_R: 0.7 V_{p-p} (75 Ω)

Jacks RCA jacks

Audio output

Output level

During audio output 200 mVrms (1 kHz, -20 dB)

Number of channels 2

Jacks RCA jacks

Digital audio characteristics

Frequency response 4 Hz to 44 kHz (DVD fs: 96 kHz)

S/N ratio 115 dB

Dynamic range 102 dB

Total harmonic distortion 0.002%

Wow and flutter Limit of measurement
(±0.001% W. PEAK) or lower

Digital output

Optical digital output Optical digital jack

Coaxial digital output RCA jack

Other terminals

CONTROL IN Minijack (3.5 ø)

Accessories

Remote control unit 1

AA (R6P) dry cell batteries 2

Audio cord 1

Video cord 1

Power cord (except for Taiwan model) 1

Operating Instructions 1

Note

The specifications and design of this product are subject to change without notice, due to improvement.

Published by Pioneer Electronic Corporation.
Copyright © 1999 Pioneer Electronic Corporation.
All rights reserved.

PIONEER ELECTRONIC CORPORATION 4-1, Meguro 1-Chome, Meguro-ku, Tokyo 153-8654, Japan

PIONEER ELECTRONICS [USA] INC. P.O. BOX 1540, Long Beach, California 90801-1540

PIONEER ELECTRONICS OF CANADA, INC. 300 Allstate Parkway, Markham, Ontario L3R 0P2, Canada

PIONEER ELECTRONIC [EUROPE] N.V. Haven 1087, Keetberglaan 1, 9120 Melsele, Belgium TEL: 03/570.05.11

PIONEER ELECTRONICS AUSTRALIA PTY. LTD. 178-184 Boundary Road, Braeside, Victoria 3195, Australia, TEL: 03-9586-6300

PIONEER ELECTRONICS DE MEXICO S.A. DE C.V. San Lorenzo Num 1009 3er piso Desp. 302 Col. Del Valle, Mexico D.F. C.P. 03100
TEL: 5-688-52-90

¥ Wα tγi]]/Wfi i^f†>>/%¥(Hfi ¥~ " «O p6C-10A, 10E→ 10A1/%«` TEL: 86-21-5866-1491

<99F00WF0D00>

Printed in Japan

<VRB1224-A>